

## Assessing Seismic Hazard of the East African Rift: a pilot study from GEM and AfricaArray

Valerio Poggi<sup>1</sup> • Raymond Durrheim<sup>2</sup> • Georges Mavonga Tuluka<sup>3</sup> • Graeme Weatherill<sup>1</sup> • Robin Gee<sup>1,6</sup> • Marco Pagani<sup>1</sup> • Andrew Nyblade<sup>2,4</sup> • Damien Delvaux<sup>5</sup>

Received: [D M Y] / Accepted: [D M Y] / Published online: [D M Y]  
© The Author(s) 2016

**Abstract** The East African Rift System (EARS) is the major active tectonic feature of the Sub-Saharan Africa (SSA) region. Although the seismicity level of this divergent plate boundary can be described as moderate, several damaging earthquakes have been reported in historical times, and the seismic risk is exacerbated by the high vulnerability of the local buildings and structures. Formulation and enforcement of national seismic codes is therefore an essential future risk mitigation strategy. Nonetheless, a reliable risk assessment cannot be done without the calibration of an updated seismic hazard model for the region. A major limitation affecting the assessment of seismic hazard in Sub-Saharan Africa is the lack of basic information needed to construct source and ground motion models. The historical earthquake record is sparse, with significant variation in completeness over time across different regions. The instrumental catalogue is complete down to sufficient magnitude only for a relatively short time span. In addition, mapping of seismogenically active faults is still an on-going task, and few faults in the region are sufficiently constrained as to allow them to be directly represented within the seismic hazard model. Recent studies have identified major seismogenic lineaments, but there is substantial lack of kinematic information for intermediate-to-small scale tectonic features, information that is essential for the proper calibration of earthquake recurrence models.

---

✉ Valerio Poggi  
e-mail: [valerio.poggi@globalquakemodel.org](mailto:valerio.poggi@globalquakemodel.org)

- 1 Global Earthquake Model Foundation (GEM), Pavia, Italy
- 2 University of the Witwatersrand, Johannesburg, South Africa
- 3 Goma Volcanic Observatory, DR Congo
- 4 Penn State University, USA
- 5 Royal Museum for central Africa, Tervuren, Belgium
- 6 Istituto Nazionale di Oceanografia e di Geofisica Sperimentale (OGS), Trieste, Italy

In this study, we use new data and Global Earthquake Model (GEM) computational tools such as the Hazard Modeller's Toolkit and the *OpenQuake* engine to perform a pilot study of the seismic hazard associated with the East African Rift. The hazard model obtained has been created using the most recent information available from scientific literature, global bulletins and local earthquake catalogues, including those from *AfricaArray* projects. In this report, in accordance with the GEM philosophy, we describe in detail all working assumptions, main processing steps, data analyses and interpretations used for the model setup.

**Keywords** Probabilistic seismic hazard analysis · GMPEs · Uncertainty analysis · Earthquake engineering · Logic-tree

## 1 Introduction

Earthquakes pose a significant risk in many regions of the Sub-Saharan Africa (SSA), more particularly along the tectonically active East African Rift System (EARS). Further away from this rift system, the remainder of SSA is largely considered a stable intra-plate region characterized by a relatively low rate of seismicity. Nonetheless, several large earthquakes have been reported in historical times. While most of earthquakes in Sub-Saharan Africa occur along the EARS (inter-plate seismicity), it must be noted that a damaging earthquake can occur anywhere, especially as cities grow and many buildings are constructed without taking potential ground shaking into account. Even moderate-sized events can prove disastrous should it occur near a city with many vulnerable buildings, as happened when a  $M_w$  5.7 earthquake struck Agadir, Morocco in 1960, causing some 15,000 deaths.

Damaging earthquakes with  $M > 6$  occur almost annually in the East African Rift, and five  $M > 7$  earthquakes have occurred in eastern Africa since 1900. The largest known event in the region is the 13 December 1910  $M_s$  7.4 Rukwa (Tanzania) event that badly cracked all European-style houses in towns on the eastern shore of Lake Tanganyika (Midzi and Manzunzu, 2014; Ambraseys, 1991a; Ambraseys and Adams, 1991). A  $M_s$  6.9 earthquake that occurred on 6 January 1928 in the Subakia Valley (part of the Kenya Rift, some 200 km northwest of Nairobi) produced a 38 km long surface rupture with a maximum throw of 2.4m and destroyed, or damaged beyond repair, all European-style houses within 15 km of the rupture, fortunately without causing casualties (Ambraseys, 1991b).

During the last decade several other events caused loss of life (Durrheim, 2016). On 5 December 2005 a  $M_w$  6.8 event caused several deaths and damaged school buildings and hundreds of dwellings in the Democratic Republic of Congo (DRC) and western Tanzania. The 22 February 2006 Mozambican  $M_w$  7 earthquake was one of the largest ever recorded in Southern Africa, producing a surface rupture with a displacement of more than 1 m (Fenton and Bommer, 2006). Shaking was felt as far away as Zimbabwe and South Africa. Four people were killed, 27 injured, and at least 160 buildings damaged. On 3 February 2008 a  $M_w$  5.9 earthquake struck the Lake Kivu region of the DRC and neighbouring Rwanda. The event was located near Bukavu (d'Oreye et al., 2008), now with a population of 700,000, and can be regarded as a "near miss". A second earthquake followed the main shock 3 1/2 hours later. Numerous buildings collapsed or suffered significant structural damage, trapping many people under rubble. At least 40 people died and more than 400 were injured.

Even more recently, a  $M_w$  5.9 earthquake that occurred on 10 September 2016 near the west shore of Lake Victoria in northern Tanzania (some 200 km to the east of the West Branch of the Rift System) caused more than a dozen fatalities and 200 injuries (USGS, 2016), in a region which was previously devoid of instrumental seismicity.

While these events caused relatively small losses, the population of the region has increased enormously over the last century and increasingly urbanized; trends that are expected to continue well into the mid-21<sup>st</sup> century. Building methods have changed from wattle and daub or timber with grass roofs, which have a large inherent resistance to earthquake shaking, to European-style unreinforced masonry constructions, which are far more vulnerable to shaking (Brzev et al., 2013). The occurrence of similar events close to a town would likely cause serious human and economic losses today.

The mitigation of earthquake risk in Africa requires coordinated action on several fronts. Firstly, seismic hazard assessments should be improved by maintaining and expanding seismic monitoring networks, supplementing historical and paleoseismic catalogues, and mapping active faults at the near-surface. Secondly, building codes should be formulated and enforced, and vulnerable existing buildings and infrastructure reinforced to prevent serious damage or collapse when subjected to strong shaking. Lastly, disaster management agencies, emergency first responders, and the general public should be trained to act effectively and sensibly during an earthquake, and equipped to deal with the aftermath. National efforts to assess and address the risks posed by earthquakes are reviewed by Worku (2014) and Lubkowski et al. (2014).

In this paper, we illustrate part of the activities completed within a USAID-funded pilot project, where we seek to gain knowledge and build capacity to mitigate and reduce seismic risk in regions affected by earthquakes associated with the East African Rift System. Within this framework, a regional probabilistic seismic hazard model based on distributed seismicity has been developed and is discussed.

## 2 Tectonics and Morphology of the East African Rift System

The African continent is a palimpsest recording a lengthy tectonic history, and the East African Rift System (EARS) is superimposed on structures formed during earlier tectonic episodes (McConnell, 1980). On a broad scale, much of it can be explained by plate tectonics and the Wilson cycle, for example the amalgamation and dispersal of Gondwana. However, there are other phenomena, such as the rise of the African Superswell (Nyblade and Robinson, 1994), that are not yet fully understood.

The EARS is an outstanding example of an active continental rift system. This divergent plate boundary runs roughly NS in eastern Africa, separating the Nubian and Somalian plates. It intercepts the Afar depression in northern Ethiopia, where a triple-junction connects it north-west to the Red Sea rift and north-east to the Gulf of Aden rift, which extends then as far as the Indian Ocean Ridge. Toward south, the EARS splits into two branches - the eastern and western rifts - that bracket the Tanzanian craton. The eastern rift extends along the coast of Mozambique, veers into the Indian Ocean, and eventually joins the Southwest Indian Ocean Ridge (SWIR). The western rift continues through Lake Malawi into central Mozambique, with several splays that extend into continental Africa.

The EARS was likely initiated in the region of the present-day Turkana Rift (Furman et al., 2006) during mid-Tertiary (Macgregor, 2015). After a first volcanic

phase, tectonic activity progressively migrated toward north triggering uplift, extrusion of flood basalts (Pik et al., 2003) and consequent development of the Ethiopian plateau - which is world's youngest continental flood basalt province - and of the Main Ethiopian Rift (Saria et al., 2014). The Western branch of the EARS formed subsequently (Roberts et al., 2012; Macgregor, 2015) around 25 Myr, simultaneously with the Eastern branch, within a spreading process that is still on going and is responsible for the largest seismicity experienced in the Africa continent.

From the seismological point of view, the region is characterised by large intrinsic attenuation, due to the presence of a low-velocity anomaly in the lower mantle, named the African superplume (Lithgow-Bertelloni and Silver, 1998; Ritsema et al., 1998; Gurnis et al., 2000), which is also responsible of the high topographic elevation of the region (Saria et al., 2014) and the associated volcanism.

### 3 Seismic Hazard Analysis - Methodology

Seismic Hazard is evaluated for the regions surrounding the EARS by developing a probabilistic model based on distributed seismicity sources. The choice of this source type was mostly driven by current data, including local earthquake catalogues, faults, focal mechanisms. Consideration was also given to a regional strain rate model developed for the area by Stamps et al. (2015) in the frame of the *GEM Strain Rate Project*.

For a given site, the distributed seismicity approach determines the probabilities of exceeding, at least once in a given time span, a set of ground motion levels of engineering interest generated by a number of seismically and tectonically homogenous earthquake source zones. In its simplest representation, each source is considered independent from others and the earthquake rupture process within zones is assumed to follow a *Poisson* process. More comprehensive descriptions of Probabilistic Seismic Hazard Analysis (PSHA) can be found for example in [Field et al. \(2003\)](#), [McGuire \(2004\)](#) and [USNRC \(2012\)](#). Calculation of seismic hazard is made through the use of the *OpenQuake*-engine ([Pagani et al., 2014](#)), an open source seismic hazard and risk calculation software developed, maintained and distributed by the Global Earthquake Model.

### 4 The SSA-GEM Earthquake Catalogue

The starting point for any PSHA is the definition of the seismicity characteristics, in terms of both the long-term recurrence as well as the seismotectonic properties (e.g. style of faulting, depth distribution etc.), for the study area. This can be done in multiple ways, but the basic - and probably the most common - approach is in the use of an earthquake catalogue. For the purposes of constraining earthquake recurrence, it is critical to identify which portions of the catalogue can be considered to be a complete record of all earthquake events indirectly reported (the historical and macroseismic component) or directly recorded (the instrumental component) on a specific area and over a certain time span.

If several catalogues are available for a given study area, information (location solutions, reported time, intensity scale) can be quite heterogeneous and some objective criteria for selection, merging and homogenisation are needed. This is



usually the case when different agencies are reporting the same events but with different magnitude types. The same issue affects source solutions, for instance when different earthquake phases, processing algorithms or base model assumptions (e.g. earth velocity structure) are used.

GEM has recently developed a set of open-source tools that helps scientists go through the catalogue harmonisation process. In this study we make use of these tools (aka GEM Catalogue Toolkit, Weatherill et al., 2016) to produce an up-to-date earthquake catalogue for Sub-Saharan Africa with homogenous magnitude representation ( $M_w$ ). Such catalogue (hereinafter SSA-GEM) is obtained by augmenting available global catalogues (e.g. ISC-Reviewed, ISC-GEM, GCMT) with information from local agencies and regional projects, particularly from *AfricaArray* temporary deployments (e.g. Mulibo and Nyblade, 2013; 2016). In the following we describe in detail the necessary steps, main assumptions and choices we faced to set up the SSA-GEM catalogue, in accordance with the GEM philosophy of complete disclosure of processing procedures.

## 4.1 Source Data

### 4.1.1 ISC Reviewed Bulletin

The manually reviewed bulletin from the International Seismological Centre (ISC, 2013) was used as one of the primary sources of information for the earthquake catalogue. The ISC bulletin covers a period ranging from the beginning of the 20th century to present day. In our selected geographic area ( $-40^\circ$  to  $20^\circ$  North,  $10^\circ$  to  $60^\circ$  East) it spans the period 1904-2013, and includes a total of 26,322 events from 89 international and national (local) agencies. Magnitude scale representation is, however, not homogenous and varies between agencies and time periods.

### 4.1.2 ISC-GEM Catalogue

The ISC-GEM global instrumental earthquake catalogue (Storchak et al., 2013; 2015) is a refined version of the ISC bulletin, which improves the accuracy of magnitude and location solutions for large global events ( $M_w > 5.5$ ) in the period 1900-2012. Events reported in the ISC-GEM catalogue are considered as reference events, which have priority over other estimates from global bulletins. Earthquake size is homogeneously represented by using moment magnitude ( $M_w$ ) from globally calibrated magnitude conversion relations. The ISC-GEM catalogue is presently in its version 3, which is the one used in this study. 285 events (out of 24,375) fall within the selected study region.

### 4.1.3 Harvard/GCMT Bulletin

The Global Centroid Moment Tensor catalogue (GCMT, Ekström et al., 2012) is a collection of moment tensor solutions for earthquakes with  $M_w > 5$ . The catalogue covers the period 1976 to present, with a total of more than 40,000 global events, 614 of which are of interest for this study. Note that within ISC bulletin, the Global Centroid Moment Tensor catalogue is indicated with two separated agency labels, HRVD and GCMT, indicating the migration of the project from Harvard (Harvard

CMT Project) to the Lamont-Doherty Earth Observatory (LDEO) of the Columbia University in 2006. Moment tensor solutions from the GCMT are considered as reference for the calibration of magnitude conversion relations used in this study.

#### 4.1.4 GEM Historical Earthquake Archive

The GEM Historical Earthquake Catalogue (GEH) is a global collection of reviewed historical records consisting of 825 events ( $M > 7$ ) covering the period 1000-1903 (pre instrumental period). Only eight earthquakes from the GEH catalogue fall within the study region. The small number is likely due to the lack of historical records in sub-Saharan Africa, and poses the problem of completeness of the regional earthquake record for large magnitudes, which may consequently bias the calibration of annual occurrence rates for these events.

#### 4.1.5 AfricaArray and regional earthquake catalogues

We extended the earthquake record by integration of three local catalogues. These catalogues are the result of regional earthquake monitoring performed with temporary and permanent seismic network installations.

- I. The Tanzanian Broadband Seismic Experiment (TZB), with 2,218 events covering the period 1994-1995 and  $M_s$  magnitude between 1.43 and 4.42 (Langston et al., 1998);
- II. The Ethiopian Plateau Catalogue (ETP), with 253 events covering the period 2001-2002 and with  $M_s$  magnitude between 1.75 and 4.05 (Brazier et al., 2008);
- III. The *AfricaArray* Eastern Africa Seismic experiment (AAE), with 1,023 events in the period 2009-2011 and  $M_s$  magnitude range 1.28-4.04 (Mulibo and Nyblade, 2016).

Although these catalogues extend the record to very low magnitudes, their primary application within the present hazard study was for the local definition of seismicity distribution patterns in order to elucidate potentially seismogenic structures within the rift system and the surrounding regions. Subsequently, these are used to improve the design of a new area source model for Sub-Saharan Africa.

**Table 1** Prioritisation of agencies for preferred location solution. Selection is done differently for separated time periods, accounting for network operation and reliability of the estimate. We refer to ISC website (<http://www.isc.ac.uk/iscbulletin/agencies>, last access August 2016) for acronyms not otherwise described in the article.

Period	Agency Priority List
1000-1900	GEH
1901-1959	ISC-GEM, ISC, ISS, GUTE, GEH
1960-1964	ISC-GEM, EHB, ISC, ISS, GEH
1965-1980	EHB, ISC, NEIC, IDC, GCMT, HRVD, GCMT-NDK, BUL, PRE, LSZ, TAN, CNG, GEH
1981-2015	EHB, ISC, NEIC, IDC, GCMT, HRVD, GCMT-NDK, AAE, ETP, TZB, PRE, LSZ, NAI, TAN, CNG, EAF, GEH

## 4.2 Location Solution

In many applications, preference for earthquake location solution should be given to local agencies, while solutions from global agencies and teleseismic events should be alternatively used in those cases where local agencies are not available on the territory (e.g. not yet established) or where large solution uncertainty exists, e.g. due to insufficient station coverage. For the case of Sub-Saharan Africa, although solutions from several local agencies are made available through the ISC bulletin, there is general lack of information regarding network operation (particularly before 1980) and metadata - including the quality of the solutions - which makes the use of their locations often questionable. Nonetheless, events recorded teleseismically are unlikely to be affected by changes in station location or operation over time, with a consequent decreased bias in the solution error for different periods of the catalogue.

For these reasons, solutions from global agencies have been preferred, while the use of solutions produced by local agencies was restricted to those cases where no other information was available. By mapping the activity period of the different seismological agencies over time **and through the use of available network information from literature, technical reports and local experts**, we identified five main time intervals and adopted a different agency prioritisation scheme for the selection of the best available location within each (see summary **Table 1**).

**Table 2** List of agencies and corresponding  $M_w$  conversion rules. Agencies are sorted according to decreasing priority for the catalogue harmonisation.

Agency	$M_w$ Conversion Rule	Range	Reference
ISC	$0.616M_s+2.369$	$M_s < 6$	Weatherill et al., 2016
	$0.994M_s+0.1$	$M_s > 6$	
	$1.084m_b-0.142$	$m_b < 6.5$	
NEIC	$0.723M_s+1.798$	$M_s < 6.5$	
	$1.005M_s-0.026$	$M_s > 6.5$	
	$1.159m_b-0.659$	$m_b < 6.5$	
PRE	$M_L$	$M_L < 6$	Assumed 1:1 scaling and arbitrary uncertainty (0.3)
BUL	$M_{blg}$	$M_{blg} < 6$	
TZB, ETP, AAE	$1.02+0.47M_L+0.05M_L^2$	$M_L < 5$	Edwards et al., 2010
PAS	$0.616(M_s-0.2)+2.369$	$M_s > 6$	ISC- $M_s$ corrected (as suggested in Engdahl and Villasenor, 2002)
	$0.994(M_s-0.2)+0.1$	$M_s < 6$	

## 4.3 Magnitude Homogenisation

An unbiased seismicity analysis requires that the seismic record is represented homogeneously in terms of the magnitude scale, to avoid inconsistencies due to the different processing schemes used for the calculation of different magnitude scales and the manifestation of saturation effects. Among the several scales that can possibly be used as reference, the most natural choice is moment magnitude ( $M_w$ ), due to its direct connection to earthquake size and energy, and the absence of saturation at high magnitudes. However, events with a native estimate of  $M_w$  (i.e. directly obtained from data) are limited, and very often a conversion from other scales is necessary.

Calibration of regional conversion rules from local datasets is generally advisable; however, it can be limited by availability of events with multiple magnitude scale representations. Alternatively, a two- (or three-) step conversion with an intermediate dummy intensity measure (IM) of larger availability can be used, with the drawback of the progressive accumulation of uncertainty at each conversion step. If no calibration data are available at all, globally calibrated conversion rules can still be applied.

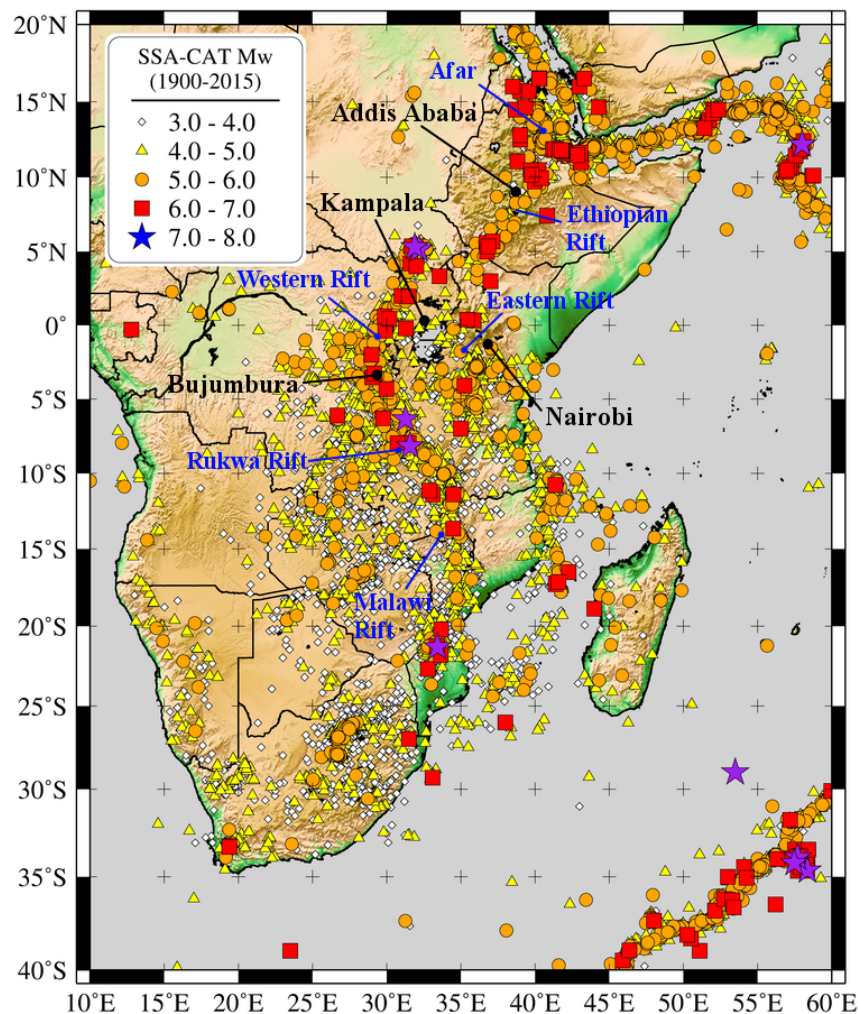

**Fig. 1** Distribution of Earthquake events ( $M_w \geq 3$ ) from the homogenised SSA-GEM earthquake catalogue. Names of the major rift systems associated with seismicity are indicated on the map with blue labels, while the four African capitals analysed at the end of this study are marked in black.

For the definition of ad-hoc magnitude conversion rules, we used in this study the functionalities offered by the GEM catalogue toolkit (Weatherill et al., 2016), which allows for the exploration and statistical analysis of local, regional and global datasets to build statistical regression models for the IM conversion. In the SSA region, unfortunately, we experienced a substantial lack of calibration data to implement local  $M_w$  conversion rules and in several cases we had to rely on globally calibrated relations (see Table 2).

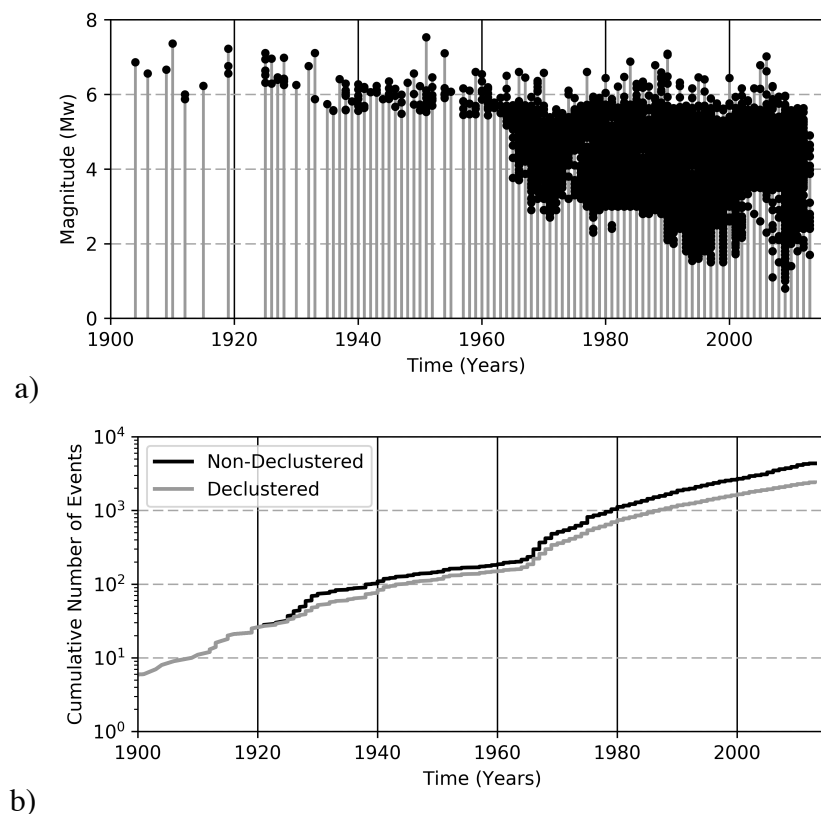

**Fig. 2** a) Distribution of seismicity over time for the events in the homogenised SSA-GEM earthquake catalogue. b) Comparison between cumulative distribution of earthquakes before (non-declustered catalogue) and after fore-/aftershock cluster removal (declustered catalogue). Historical events (before 1900) are not presented.

#### 4.4 Duplicate Findings and Catalogue Homogenisation

When merging different earthquake catalogues, one issue is the identification of duplicate events. To face this problem, events falling within a window of prescribed spatial and temporal width are assumed to represent the same earthquake. Best results have been obtained with a window of  $0.5^\circ$  and 120 s. These values appear sufficient to capture relative uncertainty in earthquake solution between agencies, which is particularly relevant for teleseismic events. The use of larger values had led to erroneous results, by misinterpreting earthquakes in aftershock sequences as duplicates. After catalogue merging, previously defined priority rules for magnitude and location agency selection are applied and the final catalogue is produced (Fig. 1 and Fig. 2a).

#### 4.5 Catalogue Declustering

A widespread assumption in standard PSHA is that earthquake occurrence rates are independent of the observation time and that their probability distribution is that of a Poisson process. However, earthquake catalogues are naturally affected by the presence of groups of correlated events (clusters), such as fore- and aftershock sequences and seismic swarms, which are highly dependent in space and time.

In order to estimate Poissonian seismicity rates, those dependent events have to be removed by filtering the catalogue prior to the calibration of any occurrence relationship. Such procedure is called catalogue declustering and several algorithms have been proposed to address this issue (see van Stiphout et al., 2012 for a review). Among others, one of the most popular is from Gardner and Knopoff (1974), due to its conceptual and computational simplicity. The algorithm isolates and removes dependent events from a sorted catalogue by virtue of a fixed time-distance window centred on each (assumed) earthquake main shock and proportional to its magnitude. Although several window variants exist (see Uhrhammer, 1986 or van Stiphout et al., 2012), we used the original magnitude-scaling relation of Gardner and Knopoff (1974). The declustered SSA-GEM catalogue consists of 7,259 events out of the original 29803 in the magnitude range  $3 \leq M_w \leq 7.53$  (Fig. 2b).

## 5 Seismic Source Zonation

The proposed seismic source model for Sub-Saharan Africa is based on distributed seismicity sources, consisting of areal zones representing uniform temporal and spatial earthquake occurrence. This approach is commonly used when observed seismicity cannot be reliably linked to any known (or inferred) geologic structure, which is often the case in low-to-moderate seismicity regions. The main advantage of using area source zones (ASZ) lies in their flexibility with regard to the definition of the properties of seismogenesis within a region, and the possibility of varying their geometries to guarantee a sufficiently large set of earthquakes to be used for the characterisation of seismicity occurrence. However, the selection criteria may be highly subjective and in few cases experts may fail to reach consensus.

For the development of the area source model we followed a mixed approach, which accounts for both observed seismicity and the geological/tectonic characteristics of the study region. Such an approach closely follows from the methodology advocated by Vilanova et al. (2014), which consists in the definition of a set of objective criteria for the delineation of ASZ boundaries. Seismicity constraints have been obtained from the analysis (completeness, occurrence rates) of the SSA-GEM earthquake catalogue, which will be discussed in more detail in the next section. Tectonic information was derived mostly from scientific literature and by integration of available datasets.



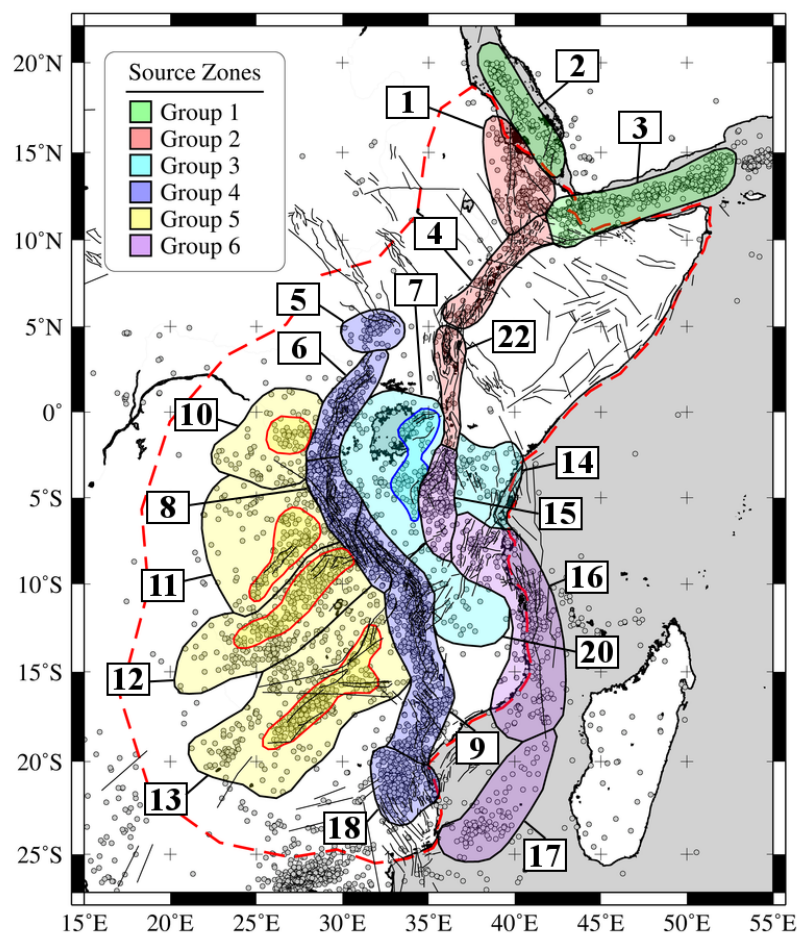

**Fig. 3** Source zonation model used in this study (see **Table 3** for details). Area sources belonging to same tectonic group are represented with unique colour. The outermost red dashed line marks the PSHA calculation area. Sub-regions of higher observed seismicity are marked with thin coloured lines for zones 7, 10, 11, 12 and 13. Plotted in the background are the SSA-GEM homogenised catalogue (non-declustered,  $M_w > 3$ ) and the faults from the database of Macgregor (2015) used in this study.

The current area source model consists of a total of 19 zones distributed over 6 main tectonic groups (Table 3, Fig. 3), which we assume to have comparable rheological and mechanical behaviour with respect to the underlying crustal geology. The definition of these groups is essential for the regional calibration of  $b$ -values. Within five zones (7, 10, 11, 12, 13), we further define sub-regions with higher observed seismicity. We assume these layers (marked with the suffix .1) to inherit all the basic seismotectonic features of the containing (background) zone, but with occurrence rates adjusted to match non-uniform spatial distribution of local seismicity. In comparison to a smoothed seismicity approach, such method has the clear advantage of being better applicable in regions of low and sparse seismicity. Moreover it is possible to account for specific tectonic features when delineating the shape of the sub-zone. In the following section we describe in detail the main seismotectonic characteristics of each group.

## 5.1 Group 1 and 2 - Horn of Africa

The Afar triple junction is a key tectonic feature in the Horn of Africa, connecting the Arabian, Nubian and Somalian plates. It represents the point of accommodation of three connected extensional regimes, which are the Red Sea and Gulf of Aden spreading ridges to the north and the Ethiopian rift system to the south.

The area around the triple junction is characterised by significant seismic activity and several large earthquakes have been observed in historical and modern times. Surface geology and focal mechanisms of earthquakes show that the region is dominated by normal faulting (e.g., Shudofsky, 1985; Kebede and Kulhanek, 1991; Ayele et al., 2006), with a minor although not negligible strike slip component. The triple junction extends to the Main Ethiopian Rift, a single extensional feature that separates the Nubian and Somalian plates (Wolfenden et al., 2004; Keir et al., 2009). Few earthquake focal mechanisms are available for the Main Ethiopian Rift, although most indicate normal faulting with an ESE-WNW orientation (Casey et al., 2006; Delvaux and Barth, 2010). To the south is Lake Turkana, which is located in northern Kenya. The area surrounding this region exhibits the lowest seismicity within group 1 and 2, with a remarkable exception of the 1928 Subukia Earthquake (MI 7.1, Mulwa et al., 2014).

We formally separate the marine Red Sea and Gulf of Aden source zones (which comprise group 1) from the inland source zones along the triple junction's southern branch that has not yet produced oceanic crust (Afar depression, Main Ethiopian Rift and the Lake Turkana depression of north Kenya, which comprise group 2). The rationale behind this choice lies in the likely different seismic attenuation behaviour of the two neighbouring regions. However, this hypothesis has to be confirmed by the analysis of local seismic recordings.

**Table 3.** Source zones of the current SSA model assembled into tectonic groups.

Group	Source Zone	Name
1	2	South Red Sea
	3	Gulf of Aden
2	1	Afar Depression - Eritrea
	4	Main Ethiopian Rift
	22	North Kenya - Lake Turkana
3	7, 7.1	Lake Victoria
	14	South Kenya
	20	Rovuma Basin
4	5	South Sudan
	6	Western Rift - Lake Albert to Kivu
	8	Western Rift - Tanganyika
	9	Rukwa - Malawi (Nyasa) Rift
	18	South Mozambique
5	10, 10.1	Walikale - Masisi
	11, 11.1	Upemba Graben
	12, 12.1	Mweru - South Katanga
	13, 13.1	Kariba - Okavango
6	15	Eastern Rift
	16	Davie Ridge
	17	Mozambique channel

## 5.2 Group 3 - African Microplates

Between the Eastern and Western branches of the EARS is the Tanzanian craton, a large, stable portion of African lithosphere generally characterised by low seismicity. The craton is mostly comprised of Archean granitic-greenstones and high-grade metamorphic rocks (e.g., Chesley et al., 1999). Although the feature is considered tectonically stable and mostly inactive, some intraplate seismicity is recorded in the environs of Lake Victoria, such as the Mw 5.9 event that occurred on 10 September 2016 (USGS, 2016). Geophysical investigations have shown evidence of a rather thick lithosphere (150–200 km) below the craton (e.g. Petit and Ebinger, 2000; Adams et al., 2012). Consequently, seismic attenuation is likely to be lower than in surrounding zones of active rifting (Saria et al., 2014).

Delineation of the source zones is predominantly based on the boundaries of microplates. Hartnady (2002) interpreted this region to be comprised of two distinct blocks, which are formally separated into the Victoria and Rovuma microplates based on their kinematic behaviour (Saria et al., 2014). The Victoria microplate consists mostly of the Tanzanian craton, and the Rovuma microplate borders to the south and extends to northern Mozambique. A sub-region of higher seismicity has been defined within the group, situated west of the Gregory Rift in southern Kenya and Tanzania. Although this region has higher seismic productivity compared to other parts of the microplate, we assume it has a similar tectonic setting, making it suitable for the calculation of a common *b*-value. Source group 3 also extends beyond the microplates to the eastern coast of Kenya and Tanzania, under the assumption that this region exhibits similarities to the rest of the source group, and is only separated geographically by the Eastern rift system.

### 5.3 Group 4 - Western Rift System

The Western Branch of the EARS exhibits the highest rates of seismicity within the study area and limited volcanic activity. From north to south this source group includes the Albertine Rift (containing the Albertine Graben, Semliki Basin and Rwenzori Mountains), the Lake Kivu Basin including the Virunga volcanic area, and the Tanganyika-Rukwa-Malawi (TRM) rift segment (including Lake Tanganyika, the Mbeya triple junction and the Rungwe volcanic province). The Malawi Rift extends along the seismically active Urema graben towards south Mozambique, where the  $M_w$  7.0 Machaze earthquake of 23 February 2006 occurred (Fenton and Bommer, 2006; [Yang and Chen, 2010](#)).

Seismicity in the Western Branch (i.e. centroid depths) extends through the entire crust and many of the larger earthquakes ( $M > 6.5$ ) have nucleated within the lower crust (Nyblade and Langston, 1995, Brazier et al., 2005; Craig et al., 2011), with hypocentres as deep as 30–40 km (Yang and Chen, 2010). Unfortunately, the accuracy of the focal depth estimates is generally poor owing to the sparse station spacing (Mavonga & Durrheim, 2009). The earthquake record is also largely incomplete before 1960 because of the substantial lack of seismic stations in the region.

Source group 4 contains five area sources, which cover several segments of the Western Branch, and delineation of the zones is predominantly based on fault orientations and stress patterns from inversion of focal mechanism data (Delvaux et al., 2012; 2016). The Albertine Rift is dominated by NE-SW normal faulting. The Lake Kivu area also displays normal faulting, but with a general N-S trend. Lake Tanganyika occupies the central part of the Western Branch, where the focal mechanisms in northern part of the lake indicate an ESE-WNW normal faulting

regime with a slight strike slip component. The southern part of Lake Tanganyika belongs to the TRM zone, interpreted by Chorowicz (2005) as the formation of an intercontinental transform extending south to Lake Malawi marked by a series of right lateral en-echelon faults. Delvaux et al. (2012) showed that the TRM segment currently opens in a NE-SW direction, orthogonal to the rift trend, and we have considered both interpretations in our source model **by specifying a probability distribution for the rupture geometry that accounts for both rake and strike orientations**. Within the TRM zone is the Kanda active fault system, located near the Rukwa Rift, which may have been responsible for the 1910  $M_s$  7.4 earthquake, the largest recorded in the East Africa Rift (Vittori et al., 1997).

## 5.4 Group 5 – Central Africa

The Central Africa group encompasses the region west of the Western Rift, extending to parts of the Democratic Republic of Congo, Zambia, Zimbabwe, and Botswana. The northern area includes the very eastern Congo Basin (Masisi zone), where seismicity decreases moving away from the Western Rift. The southern zones are characterised by a series of NE-SW trending rifts (Upemba, Mweru, Kariba Rifts), striking roughly perpendicular to the Western Rift.

Four area sources are used to characterise this group, each with a sub-region of higher seismicity. The northernmost area, the Masisi zone, is located northwest of Lake Kivu. A study of earthquake focal mechanisms by Tanaka et al. (1980) showed that the direction of the fault traces in that area is SE-NW, and the average focal mechanism is normal faulting with the tension axis perpendicular to the strike of the fault traces. The last strong earthquake occurred in the Masisi area on 29 April 1995 ( $M_b$  5.1, Mavonga, 2007;  $M_w$  5.4, Barth et al., 2007). To the south, the most prominent seismotectonic features are the Upemba and Mweru Rifts. The Upemba Rift is characterized by a NE-SW striking fault extending along its eastern side (Studt et al., 1908). It may extend northward to the Kabalo area, which experienced an earthquake with magnitude  $M_w$  6.5 on 11 September 1992. Detailed investigation has revealed that the main geological features in the Kabalo area trend in the NNE-SSW direction, similar to those found in the Upemba Rift (Zana et al., 2004).

## 5.5 Group 6 - Eastern Rift System

The Eastern Branch of the EARS extends from the rift systems of north Kenya to the offshore coast of Tanzania and Mozambique, along the Davie fracture zone. The northern segments can easily be tracked starting from the Turkana basin and moving southward along the system of rifts marking the eastern boundary of the Victoria microplate. Seismicity in the Eastern branch is less pronounced compared to its Western counterpart, and mostly concentrated in the southern segments (Manyara region). The segments of the Eastern branch are conversely characterised by a large volcanism (e.g., Dawson, 1992; Yang and Chen, 2010; Craig et al., 2011) that commenced about 25 Myr with the rifting of the Turkana region (Furman et al., 2006; McDougall and Brown, 2009).

The source zones are mainly delineated based on seismic activity. South of the large seismicity gap that is observed along the Kenya and Gregory rifts, a zone of seismicity commences in central Tanzania, representing the northernmost source zone

in this group. The southern continuation of the Eastern Branch is however highly uncertain and the definition of the source zones is mostly controlled by the offshore seismic activity of Mozambique (Hartnady, 1990; Hartnady et al., 1992), which is quite diffuse along the Davie Ridge (Grimison and Chen, 1988; Franke et al., 2015) and its southern continuation.

## 6 Building the Seismic Source Model

In this section we illustrate the process adopted for the construction of the earthquake source model. Each source in *OpenQuake* requires the characterisation of a three-dimensional finite rupture, whose properties are consistent with the seismotectonics of the region. A comprehensive description of an area source representation in *OpenQuake* can be found in Pagani et al. (2014).

### 6.1 Source Depth Distribution

A model for source depth distribution was derived based on the available information from the SSA-GEM catalogue. Unfortunately, not all reported events included an estimation of hypocentral depth solution. In few cases, although available, such estimate was considered unreliable because of the large uncertainty (generally at depths larger than 40 km) or because the depth was explicitly assigned a-priori (e.g. fixed solution depths of 5, 10, 15 and 33 km). These events have been removed from the analysis. Nonetheless, a sufficient number of samples was available to perform a reasonable statistical analysis (Fig. 4).

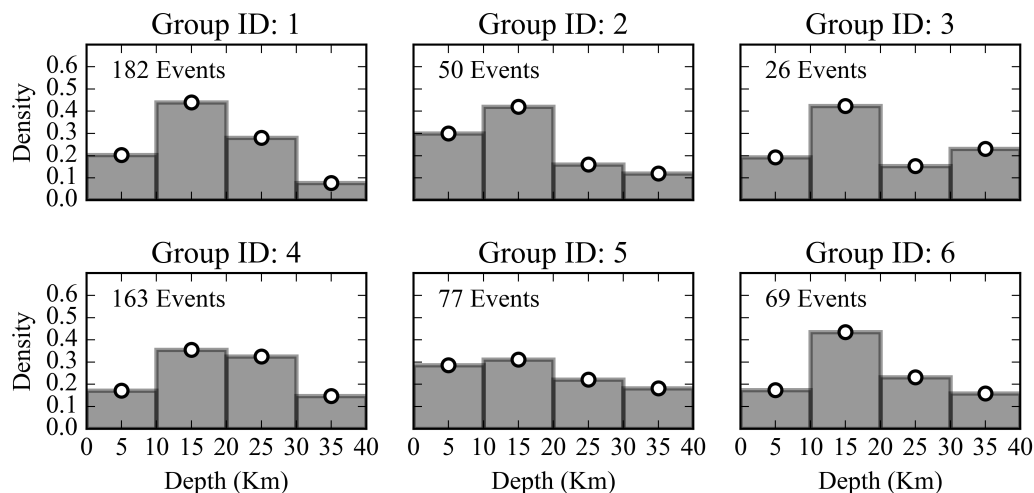

**Fig. 4** Distribution of the hypocentral depth solutions of earthquake events falling into the main six source groups defined in **Table 3**. The largest contribution comes persistently from the depth range between 10 km and 20 km, although many events are also observed at depths up to 40 km.

### 6.2 Source Mechanism

Geometry of the source is fully described by the focal mechanism parameters strike, dip and rake. While strike and dip uniquely describe fault orientation, rake is used to further specify the rupture kinematic (normal, thrust, strike-slip or oblique). Such source parameters can be estimated directly by the analysis of fault-plane solutions from moment tensor inversion of earthquake recordings, or indirectly by the analysis of local and regional stress regimes and existing geological structures. We based our considerations on the geological and seismological literature available for the area (see section 5).

The tectonic regime in the study region is mostly extensional, although a minor but not negligible transform component is also observed in many areas. Normal faulting style was modelled by imposing a standard (constant) dip angle of  $60^\circ$  and rake of  $90^\circ$ , adding where necessary a strike-slip component by allowing oblique strike on the fault plane. Since in most cases precise information on average slip direction was not available, either left lateral ( $-45^\circ$ ) and right-lateral ( $-135^\circ$ ) rake components were allowed with equal probability.

The overall strike distribution was calibrated by performing statistical analysis on the outcropping fault structures available from the database of Macgregor (2015). To do this, we split fault traces into segments of fixed length (1 km), in order to weight segments of different length proportionately, but also to avoid issues related to arbitrary segmentation of main faults. Segment statistics were then used to constrain average strike orientation in each zone (e.g. Fig. 5). In a few cases, bimodal (and even more complex) distributions were found, which are likely due to a mixed tectonic regime. In those cases, no sufficient data were available to constrain a predominant orientation, thus we based our judgement on available moment tensor solutions and tectonic regime descriptions from literature, or alternatively by using an isotropic (equal-probability) distribution.

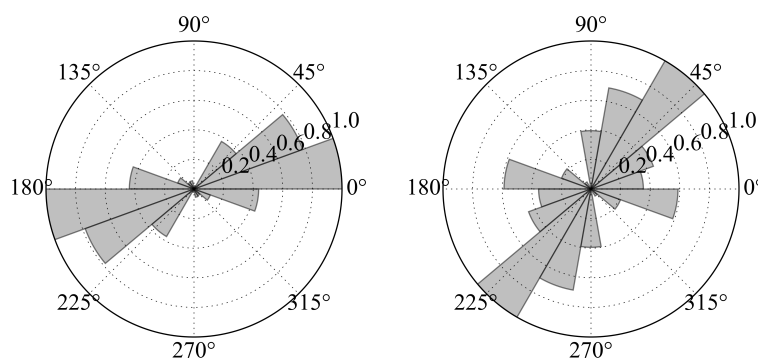

**Fig. 5** Distribution of fault orientation (strike) for two example source zones (4 and 7). Input information is from the fault database of Macgregor (2015).

## 6.3 Seismicity Analysis

### 6.3.1 Completeness Analysis

Earthquake catalogue completeness (Rydelek and Sacks, 1989; Woessner and Wiemer, 2005) is evaluated for different temporal periods and magnitude ranges by integration of two complementary procedures. First, results from the unsupervised



Stepp (1972) algorithm are evaluated, using the implementation available within the GEM's Hazard Modeller Toolkit (HMTK) (Weatherill, 2014a). This method, however, proved to be unstable, giving potentially erroneous results in the case of sparse and irregular data coverage, as it is unfortunately the case for Sub-Saharan Africa. As subsequent refinement, therefore, we have manually adjusted the retrieved completeness thresholds by evaluating the variability of occurrence rates over time (e.g. Fig. 6) and by investigating its impact on the magnitude frequency distribution (as discussed in the next section). Several iterations of progressive adjustment were required to converge to a stable and satisfactory result. In a first stage, a unique completeness was evaluated for the whole study area (e.g. Fig. 6). From that, results were subsequently refined for each source zone group to account for local specificities (e.g. due to non uniform spatial distribution of seismicity), while keeping the total rate balance unmodified.

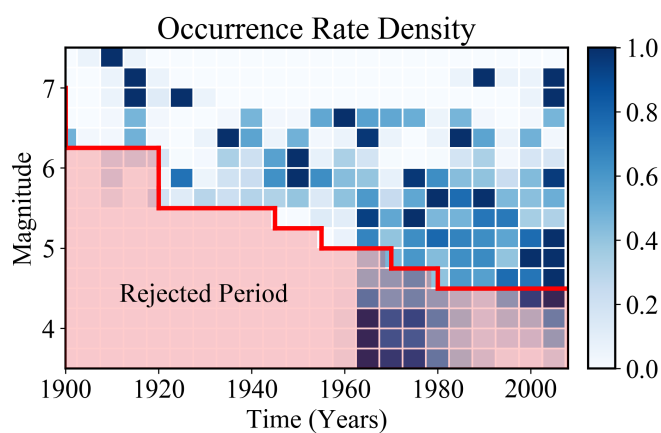

**Fig. 6** Magnitude-time density plot of the SSA-GEM catalogue. Normalised rates are computed for fixed time windows of 5 years and for a 0.25 magnitude unit increment. Incomplete data periods (and other periods rejected from further interpretation) are marked with the pink shaded area.

### 6.3.2 Magnitude-Frequency Distribution

Seismicity in each area source is assumed to follow a double truncated Gutenberg-Richter magnitude occurrence relation (or magnitude-frequency distribution, MFD). Lower truncation is arbitrarily assigned to  $M_w$  4.5 (lowest magnitude threshold considered capable of generating damage) for all zones. Upper truncation is defined as the magnitude of the largest earthquake assumed possible (or, rather, plausible) for an area. A different maximum magnitude ( $M_{MAX}$ ) estimate is derived independently for each source group as the largest observed event plus an arbitrary - although quite conservative - increment of 0.5 magnitude units.

Gutenberg-Richter  $b$ -values have been calibrated for the whole catalogue and independently for each source group. Conversely, occurrence rates ( $a$ -values) have been calculated separately for each source zone by imposing the previously calibrated  $b$ -values. This strategy was necessary given the limited amount of data available for the study area, and particularly for those zones of quite limited extension.

In addition to using standard and well-established approaches (e.g. Weichert's maximum likelihood method; Weichert, 1980), we tested and compared results from an alternative strategy we developed based on direct inversion of incremental (non-cumulative) earthquake occurrences using a nonlinear least-square approach. Seismicity parameters ( $a$ - and  $b$ -values) are obtained by minimizing the residuals between observed rates in discrete magnitude bins and a theoretical non-cumulative

MFD model (e.g. Fig. 7). Such strategy is advantageous in that target observations are independent and the results are therefore not affected by discontinuous earthquake records, as for the case of uncertain completeness of reported large magnitudes. Moreover, a variety of *a priori* constraints (e.g. fixed *b*-value or maximum magnitude) can easily be included in the analysis.

### a) Group 1

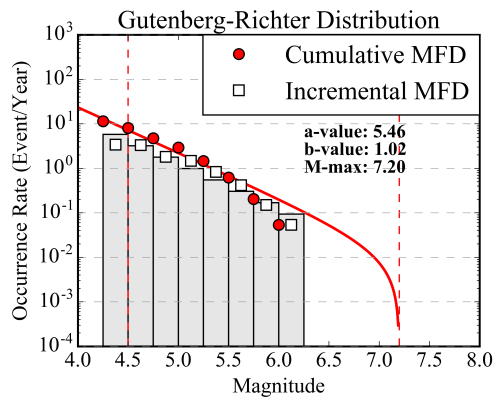

### b) Group 2

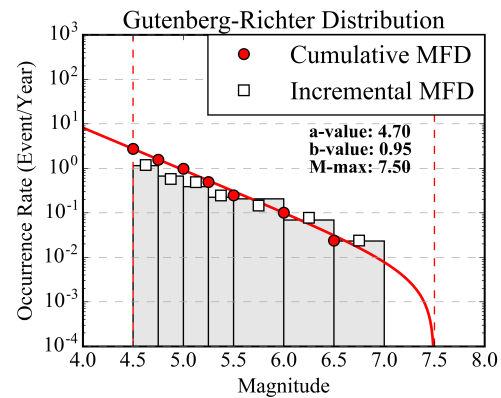

### c) Group 3

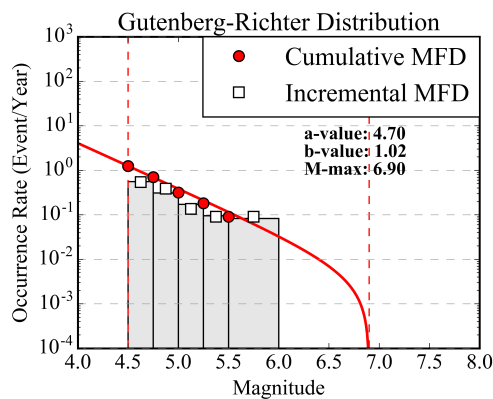

### d) Group 4

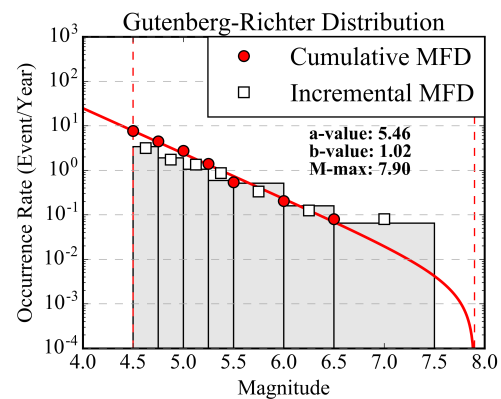

### e) Group 5

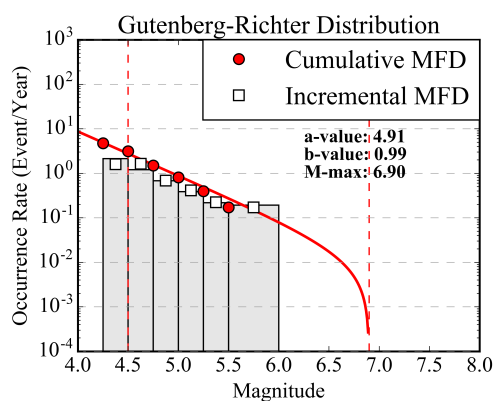

### f) Group 6

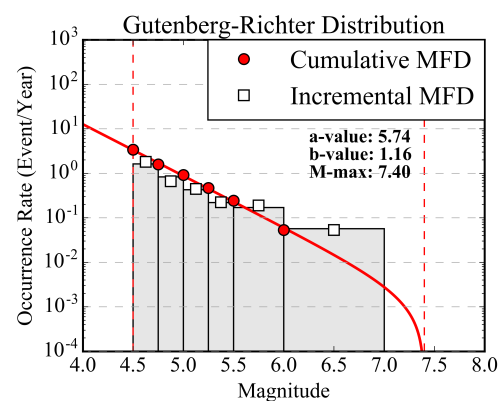

**Fig. 7** Gutenberg-Richter magnitude occurrence relations of each tectonic group computed from the declustered SSA-GEM catalogue. White squares and red dots are respectively the observed incremental and cumulative occurrence rates, while the grey histogram and the red line represent the incremental and cumulative rates from the inverted Gutenberg-Richter relation. It must be noted that the width of non-cumulative magnitude bins is not uniform, as this is not a requirement of the fitting method.

### 6.3.3 Earthquake Rate Balancing

In order to avoid duplicate counts of events on overlapping zones (e.g. 12 and 12.1), an appropriate redistribution of seismic rates is necessary. Background events have to be removed from the rates computed for the topmost overlapping layer, so that joint calculation of the occurrence rates for the two zones will keep the total balance unmodified. In order to do so, the unit-area background rate is obtained by counting the occurrences in the background region not falling also into the overlapping layer. This can be done by simple subtraction of the total events observed in the two zones. The background rate is then removed from the occurrence of the overlapping zone after rescaling by local area extension. For simplicity, we limited this procedure to just one single overlapping zone, but such a strategy can nonetheless be extended to the use of several layers, each delimited by contouring the average density level of events over the area. This **last** approach would be an intermediate approach between standard distributed and **gridded** seismicity models, **where the occurrence rates for a unit area could vary over the zone, while keeping the total rate balance unmodified.**

**Table 4** Calibrated seismicity parameters for each source zone, divided by tectonic group. Sources marked with .1 are representing overlapping layers within a background zone.

Group	Source	<i>a</i> -value	<i>b</i> -value	M-max
1	2	4.83	1.02	7.2
	3	5.38		
2	1	4.48	0.95	7.5
	4	4.18		
	22	3.70		
3	7	4.00	1.02	6.9
	7.1	4.23		
	14	4.34		
	20	3.31		
4	5	4.22	1.02	7.9
	6	4.89		
	8	4.84		
	9	4.93		
	18	4.40		
	10	3.90		
5	10.1	3.92	0.99	6.9
	11	3.51		
	11.1	3.93		
	12	4.05		
	12.1	4.13		
	13	4.08		
6	13.1	3.99	1.16	7.4
	15	5.31		
	16	5.45		
	17	4.77		

## 7 Logic Tree Implementation

While the aleatory (or random) component of the model uncertainty is generally taken into account through the hazard integral, the epistemic component, which is related to the available level of knowledge and/or the adopted initial assumptions and simplifications, can be quantified by using a logic-tree strategy. In a logic-tree approach, different interpretations of the model components are considered concurrently. Statistical analysis is performed *a posteriori* on the weighted outcome of each model realisation (or logic-tree branch). *OpenQuake*-engine allows the use of separate branching levels, each of those representing a separate contribution to uncertainty. A multi-level strategy ensures the full exploration of the model variability by computation of all possible permutations of those model parameters affected by epistemic uncertainty. We applied this strategy to account for the difference between existing ground motion prediction models and for the variability of source parameters not directly constrained by available data.

### 7.1 Ground Motion Prediction Equations

The optimum strategy for the selection of the most representative Ground Motion Prediction Equations (GMPE) is the direct comparison of empirical ground motion estimates with observed earthquake recordings in a sufficiently representative range of magnitudes and distances. The GEM Ground Motion Toolkit (GMTK) offers a set of simple functionalities to pursue this goal (Weatherill, 2014b). Unfortunately, Sub-Saharan Africa is affected by a severe lack of data availability. The use of *AfricaArray* networks did not contribute significantly, as no large magnitude events were recorded and the lack of recordings in the near to intermediate distance range (<50km). For these reasons, we had to rely for GMPE selection on a simpler - but less accurate - selection criteria, based on direct evaluation and comparison of GMPE features, such as the tectonic setting, the type and quality of data used for calibration, and the suitability of the functional form (Cotton et al., 2006).

In a first round, sixteen GMPEs were selected as possible candidates from a worldwide database, covering four different tectonic contexts: active shallow crust (ASC), stable continental crust (SCC), cratons (CRT) and volcanic areas (VLC). However, ground motion prediction equations from CRT and VLC settings were excluded, because of the questionable applicability to the investigated area and the lack of available data to perform ad-hoc ground-motion analysis. This last issue is particularly critical in case of volcano-related seismicity, which is nonetheless a possibly significant contribution to seismic hazard at specific sites. Once more data is made available, it is advisable that this component will be progressively integrated into the model.

In a second attempt, GMPEs for ASC and SCC were assigned to different source groups. While we used ASC GMPEs for areas involving plate boundary segmentation, SCC GMPEs were used to model ground motion in all intra-plate areas. The rationale behind this choice is the evolution of the African rifting. Given the relatively young age of the process, it might be expected that extra-rift regions are less exposed to asthenospheric upwelling, and therefore able to preserve a mechanical

behaviour and a seismicity footprint typical of stable continental areas. However, after some sensitivity test calculation, we found that using a sharp separation between regions of different tectonic setting led to unjustifiably large differences in the computed ground motion across certain zone boundaries. In order to minimize such effects, while retaining the assumption of diversity in crustal attenuation and stress-drop, we proceeded with an alternative approach.

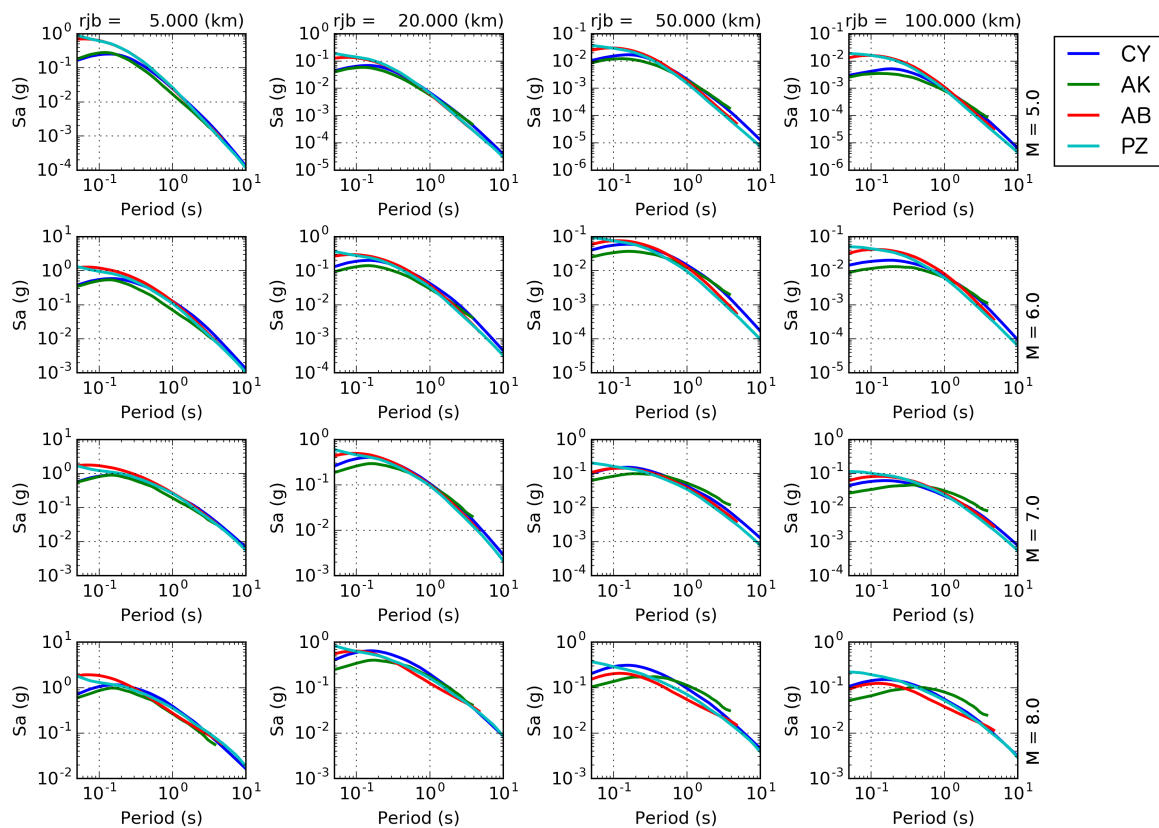

**Fig. 8** Comparison between response spectra predicted by the four selected GMPEs as a function of  $M_w$  magnitude (rows,  $M_w$  5 to  $M_w$  8) and Joyner-Boore distance (columns, 5 km to 100 km).

**Table 5** Weighting scheme used for the GMPE logic tree. Source zones sharing the same weights are grouped into four main categories (A-D). Four attenuation models were applied (CY - Chiou and Youngs, 2014; AK - Akkar et al., 2014; AB - Atkinson and Boore, 2006; PZ - Pezeshk et al., 2011).

Group ID	Source ID	CY	AK	AB	PZ
A	1, 2, 3, 4, 17	0.5	0.5	0	0
B	5, 6, 8, 9, 1, 8, 22	0.375	0.375	0.125	0.125
C	15	0.25	0.25	0.25	0.25
D	7, 10, 11, 12, 13, 14, 16, 20	0.125	0.125	0.375	0.375

The current logic-tree model was restricted to the use of four GMPEs, respectively two for active shallow crust (CY - Chiou and Youngs, 2014; AK - Akkar et al., 2014) and two for stable continental conditions (AB - Atkinson and Boore, 2006; PZ -

Pezeshk et al., 2011). We then assigned all of the selected GMPEs to each source zone, but allowing the corresponding logic-tree weight to vary in agreement with the likelihood for each specific tectonic type. Assignment of weights was agreed on the basis of the direct judgement of local seismotectonic conditions by a pool of experts from the region. The full list of weights is summarised in Table 5. Zones sharing the same weighting scheme have then been clustered into four main groups (named A to D) to reduce the total number of end-branches into the logic tree implementation. In Fig. 8 a comparison of the response spectra from the selected GMPE is presented for a range of magnitude and distance values.

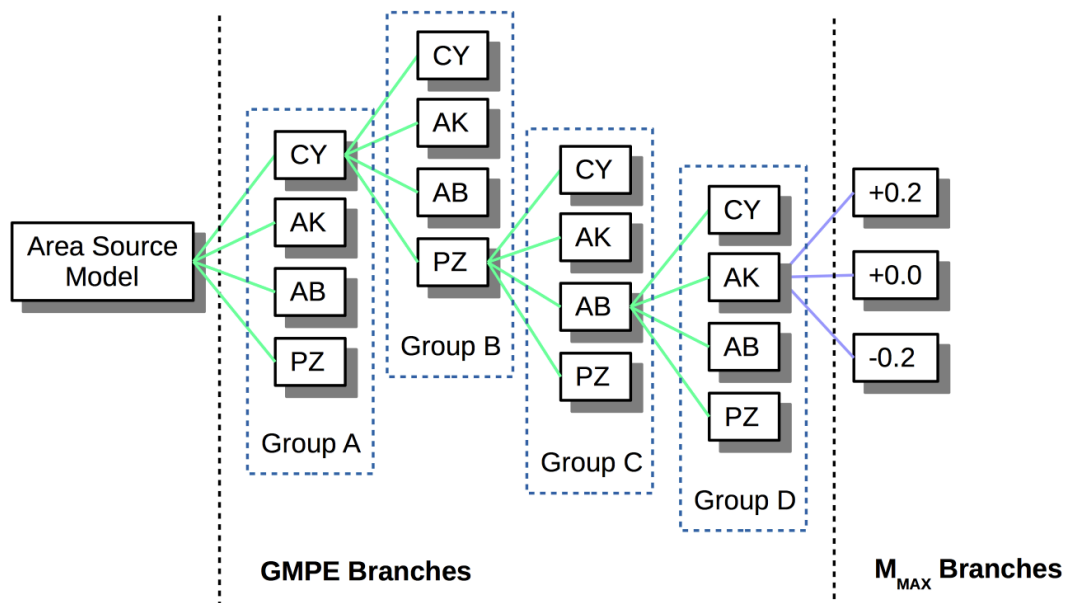

**Fig. 9.** Schematic representation of branch permutation for the current logic-tree implementation. **Four independent branching levels are first used to characterise the four main tectonic groups (A-B-C-D) for the area. For each group, different weighting is then assigned to the selected GMPEs (see Table 5). An additional branching level is finally implemented to explore the variability of source parameters within each group. Given the explorative nature of the study, we presently only consider the uncertainty on maximum magnitude (M<sub>max</sub>).**

## 7.2 Source Model Uncertainty

Given the explorative nature and the initial goals of the present study, the source model logic tree has currently a single master branch that includes the area source zonation previously described. Using a single zonation model has a clear impact on the epistemic variability of the hazard results. We envisage the integration of alternative area source interpretations as a possible extension of this study, as the result of the contribution of a wider community of African scientists.

On top of that, additional branching levels have been implemented to describe the epistemic variability of the assumed maximum magnitude of each zone (e.g. Fig. 9). Given the poor constraints available for its definition, maximum magnitude is assumed to have a relative possible error of  $\pm 0.2$ , assigned empirically with a certain



level of conservatism. The higher weight (0.5) is assigned to the original unmodified magnitude estimate, while edge values ( $\pm 0.2$ ) have a lower probability of 0.25 each. We presently did not account for uncertainty on occurrence rates and b-values, although we acknowledge this is a necessary subsequent improvement of the model, which would eventually impact the epistemic variability of the results.

## 8 PSHA Results

### 8.1 *OpenQuake* Settings

Hazard computations have been performed using the *OpenQuake*-engine (Version 2.0) through the available calculator for distributed seismicity (see *OpenQuake Reference Manual* for details on available calculators). The investigation area consists of a mesh of 79109 sites spaced at approximately 10 km. Such area includes all earthquake source zones described in section 3, plus a buffer region of not less than 100 km. For each site of the mesh, free rock conditions are assumed, with a fixed 30-metre averaged shear-wave velocity ( $V_{s30}$ ) reference of 600 m/s (corresponding to stiff-soil transition in Eurocode8 [CEN, 2004] and NEHRP [BSSC, 2001] classification). We choose this rock condition because we believe it is more representative of a realistic outcropping rock (which should include a certain degree of fracturing and weathering) than the more commonly used hard rock assumption with a  $V_{s30}$  equal to (or higher than) 800m/s. The choice of the reference condition is nonetheless quite arbitrary, and adjustments can still be applied subsequently to conform to a different reference.

Target ground motion intensity for calculation is 5% damped response spectral acceleration (in g), estimated for probabilities of exceedance (PoE) of 10% and 2% within an investigation time of 50 years. This corresponds respectively to return periods of about 475 and 2,475 years. Due to the substantial lack of historical records for proper calibration of the large magnitude rates, we avoid using longer return periods.

According to the possibilities of the selected GMPEs, spectral acceleration has been computed at PGA and for the response spectral periods of 0.05 s, 0.1 s, 0.2 s, 0.5 s, 1 s and 2 s. Ground motion distribution has been conservatively truncated at  $\pm 3 \sigma$ . Output of the calculation are mean and quantile (0.15, 0.5 and 0.85) hazard curves at each site, together with Uniform Hazard Spectra (UHS) and hazard maps, which are described in the next sections.

### 8.2 Calculation Outputs

Hazard calculations have been performed for each site of the investigation grid. For the sake of conciseness, however, in the following we illustrate hazard results for four selected African capitals, which are considered to be significant for risk analysis:

- Addis Ababa (Ethiopia);
- Kampala (Uganda);
- Nairobi (Kenya);

- Bujumbura (Burundi).

### 8.2.1 Earthquake Hazard Curves

Hazard curves are calculated for fixed acceleration values between 0.005 g and 2.13 g for each prescribed spectral period (including PGA). Acceleration corresponding to the target probability of exceedance(s) is subsequently extracted from the curves by linear interpolation. The mean hazard curves for different spectral periods at the four example locations are presented in **Fig. 10**. The unusual behaviour of the hazard curves in Kampala at long periods should be noted; this is likely due to concurrence of GMPEs for shallow crust and stable continental conditions, which affect the various probabilities differently.

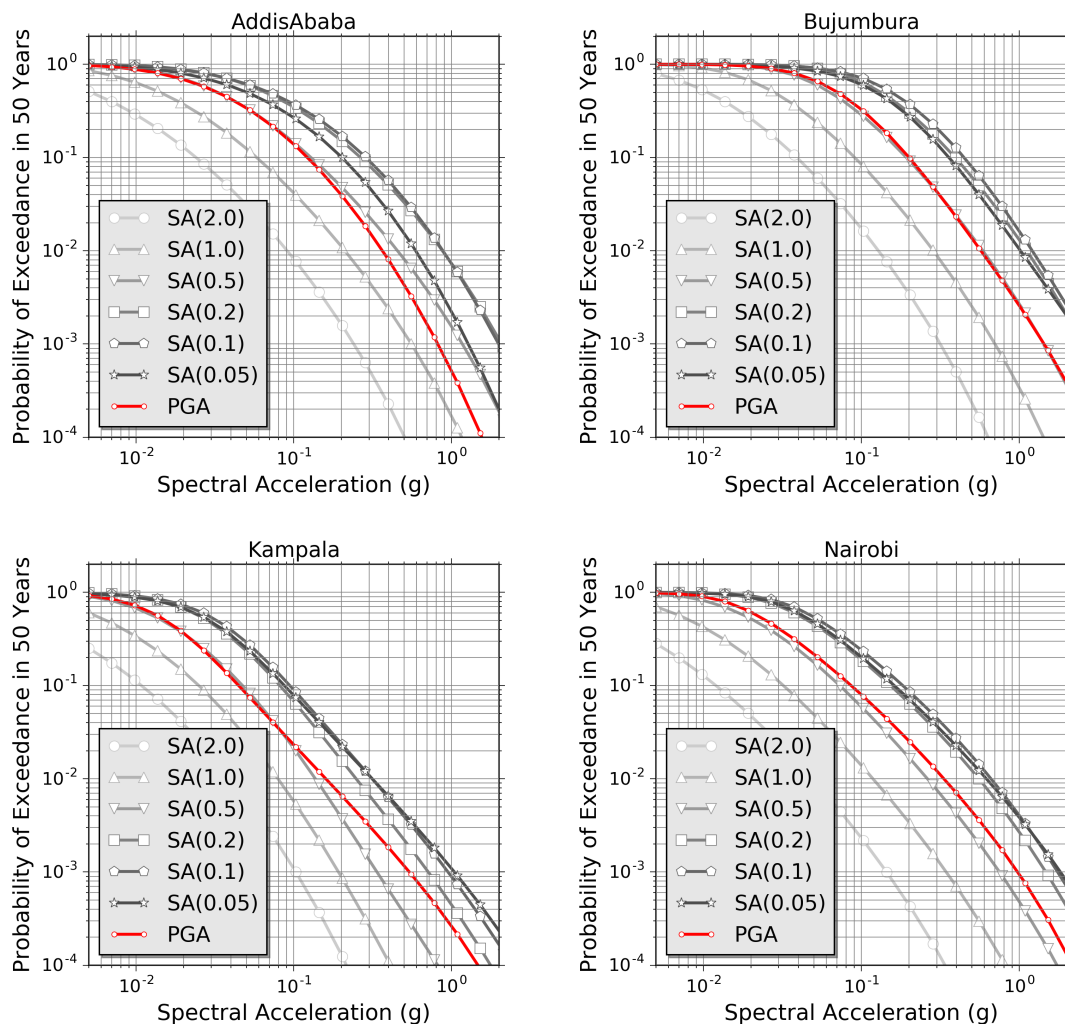
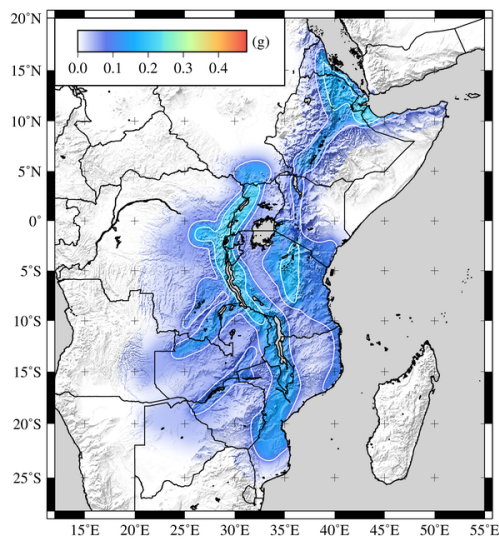
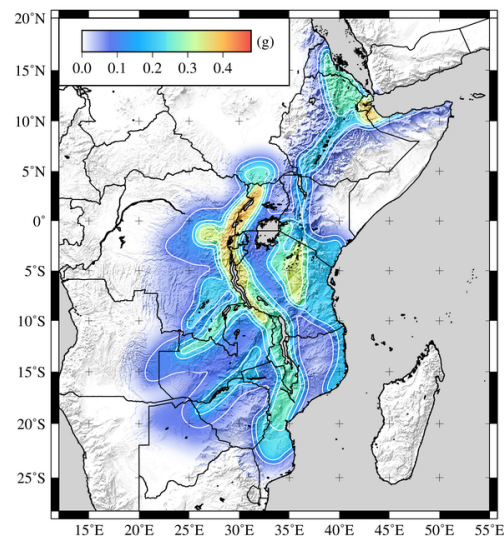
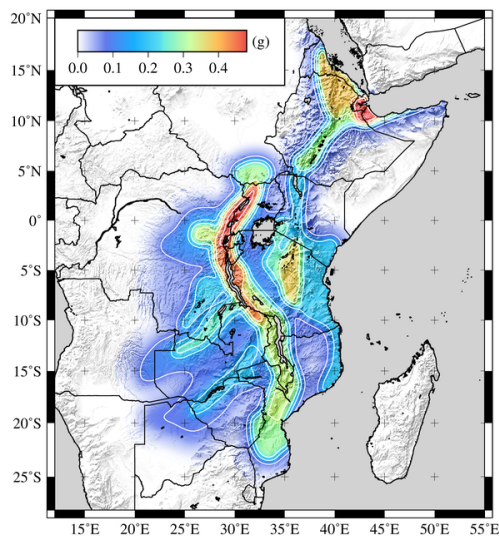
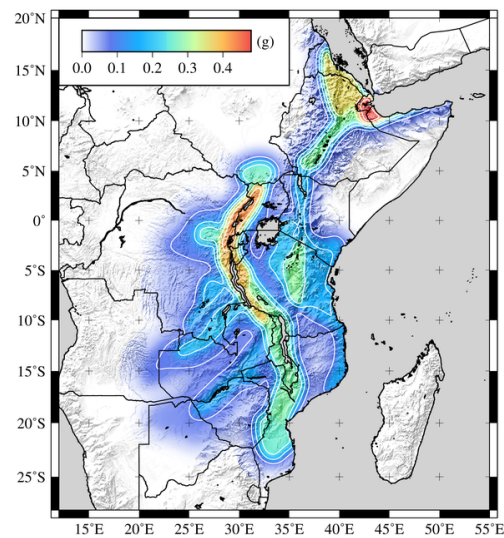

**Fig. 10** Mean hazard curves computed for a range of spectral periods, including PGA (in red), at four example African cities.

### 8.2.2 Earthquake Hazard Maps

A series of hazard maps have been produced for different spectral periods and PoEs. In the following we will focus on discussing the results for a 10% PoE in 50 years (Fig. 11), as the associated mean return period is commonly used to characterise the seismic behaviour of non-critical facilities.

Largest spectral accelerations are found for periods of 0.1 s and 0.2 s along the Western Branch of the EARS (0.51 g), particularly for source zones 6 (Lakes Albert to Kivu) and 8 (Lake Tanganyika). Moderate accelerations (less than 0.35 g) are expected in the Afar region (zone 1) in northern Ethiopia. Southern Ethiopia (zone 4) presents levels (0.24 g at 0.2s) that are comparable to western EARS (zone 15) and the side seismic belts of Zambia (zone 12). Remaining portions of the rift are affected by an overall lower hazard, with accelerations generally lower than 0.2 g.

**PGA)****0.05)****0.1s)****0.2s)****0.5s)****1s)**

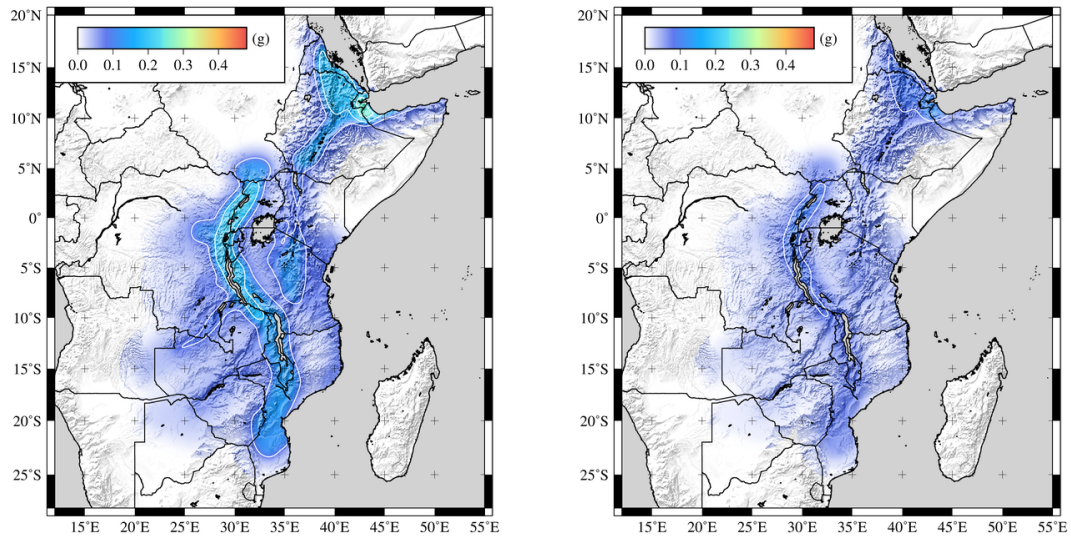

**Fig. 11** Map of spectral acceleration (g) for 10% probability of exceedance in 50 years.

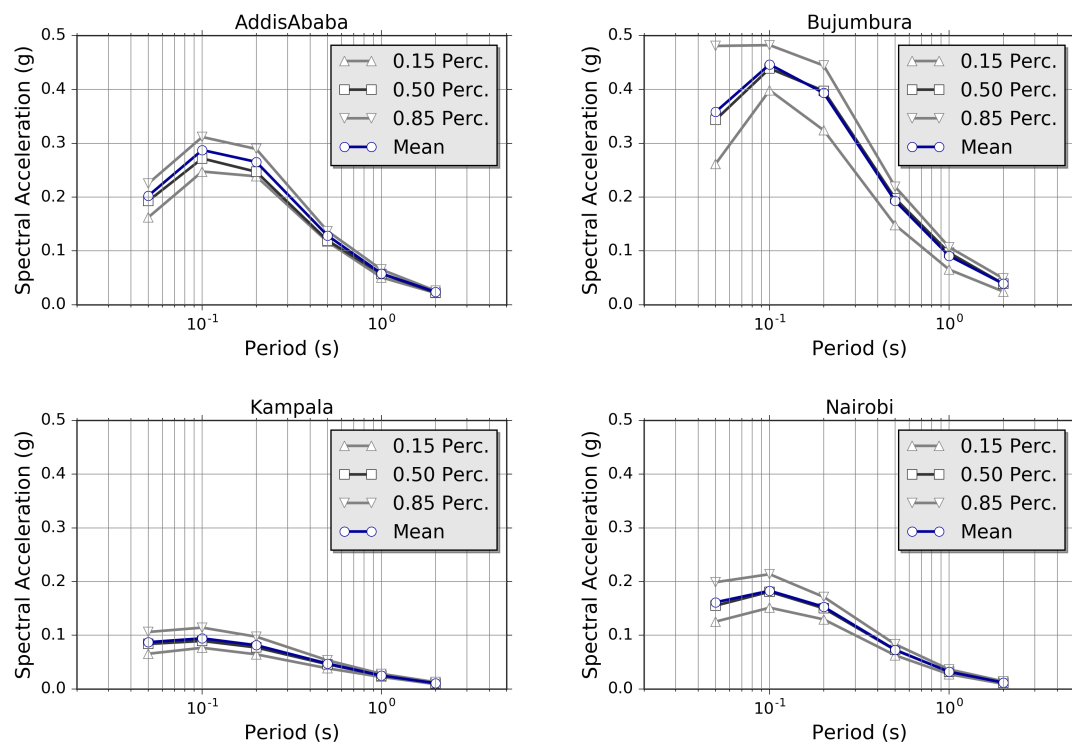

**Fig. 12** Mean and quantile Uniform Hazard Spectra (UHS) computed at the four selected African capitals for 10% probability of exceedance in 50 years (475 year return period). It is worth noting how the mean and the 0.5 percentile curves are generally in good agreement and overlapping, with the only noticeable exception of Addis Ababa in the 0.1s to 0.2s spectral period range.

### 8.2.3 Uniform Hazard Spectra

Uniform Hazard Spectra (UHS) are computed by collecting ground motion for a



given probability of exceedance over a spectrum of different response periods. This representation is useful to highlight those periods where larger spectral acceleration is expected. It is however important to stress that UHS cannot be directly used to model local scenarios (e.g. for the selection of a reference earthquake), as the different spectral ordinates might be (and likely are) linked to different controlling events (e.g. Reiter, 1990). For that purpose, a disaggregation procedure is best suited.

In Fig. 12 mean and quantile UHS are shown for the four selected African capitals (10% PoE in 50 years). It is evident that periods between 0.1 s and 0.2 s make a considerable contribution to the hazard, as the largest ground accelerations are to be expected in this range. Among possible explanations, this phenomenon may be related to the residual contribution in the ground motion model of seismic site-effects (e.g. high-frequency resonance) not adequately accounted for in the GMPE site term, particularly when a single soil-class predictor - such as the  $V_{s30}$  - is used (e.g. Poggi et al., 2016). The affected period range is, however, significant from an engineering perspective, as it matches the resonance response of typical buildings in urban environments.

## 9 Discussion and Conclusions

The SSA PSHA model is generally consistent with the previous regional model from the GSHAP project (Midzi et al., 1999), however with some noticeable differences. Starting from north, the largest PGA (10% PoE in 50 years) of the SSA model is observed in Djibouti (0.22 g) and at the border with Somalia. The value nearly matches the GSHAP prediction for the same area. Different values are, however, obtained in northern Ethiopia and the Afar region, where the current model predicts a somewhat lower acceleration (0.16 g) than GSHAP (around 0.2 g). This is likely due to the different approach used to represent multiple area sources at the Afar triple junction.

Moving southward, the maximum acceleration in the Ethiopian plateau shows similar values (0.13 g) for the two models. Following the western branch of the EARS, the biggest difference is found in the south Sudan cluster (Juba region), where a difference in acceleration of about 0.08 g is observed. This is again likely due to the different modelling strategy of the area sources. GSHAP does not define an *ad-hoc* source zone to describe the cluster, therefore transferring the moderate seismicity of the lakes region also to the north. A similar situation is found towards the south, where the SSA model predicts a slightly lower acceleration for the Lake Tanganyika (0.2 g) if compared to the region of the northern lakes (Kivu, Edward and Albert). Conversely, the southern tail of the western branch (e.g. in Malawi) shows a considerably higher acceleration (0.15 g) than GSHAP (0.08 g), which we could explain in term of the expanded catalogue and different calibration of seismicity parameters.

Again, the eastern branch of the EARS has similar maximum accelerations to the GSHAP model in northern Tanzania, but some differences are observed in the intra-plate background seismicity of the Victoria micro-plate and southern Kenya. A feature of GSHAP that does not appear in the SSA model is a seismic belt in southern Zimbabwe. No evidence of seismicity is observable from the SSA-GEM catalogue for this feature, although a system of faults is documented in the literature.

The major issue affecting the SSA model is the shortage of strong-motion recordings within a sufficient distance to be used for selection and validation of

existing ground motion prediction models. In this study, a choice of suitable GMPEs have been based on the crustal structure of the EARS, relying on a set of assumptions from seismotectonic considerations that still need full validation. Future installation of new strong-motion stations at potentially hazardous sites and the strengthening of existing seismic networks will be an essential advancement to verify the applicability of existing ground motion prediction models and to promote the development of new locally-calibrated ones. Moreover, the availability of strong-motion recordings will support site-specific hazard studies, which require empirical data for the calibration and verification of numerical seismic-response models. Note, however, that calculation of site-specific hazard is impractical for such a large area. For city scenarios, however, the use of site-specific information from local investigations and microzonation studies is highly advisable. This is a possible second-phase extension of this study.

By analysing the completeness periods of the SSA-GEM catalogue, it is also evident that additional information is required to fill significant gaps in the past earthquake record. This issue is particularly evident for the large-magnitude events, whose occurrence rate estimates could be improved by new historical and macroseismic studies, as well as by progressive integration of paleoseismic and geodetic information, which are nowadays of very limited availability. To compensate for this lack of information, GEM is presently evaluating the potentialities of a strain rate model recently developed by Stamps et al. (2015). We plan to use the inferred geodetic strain rates to derive estimates of total scalar moment release, subsequently needed to constrain earthquake recurrence relationships for both area (as distributed seismicity) and fault source models. The rates obtained indirectly from strain rates and more classically derived from the available seismic catalogues will be compared and combined into a unique mixed earthquake recurrence model, subsequently used as the base for seismic hazard calculations.

Improvements are also possible in the design of the logic tree structure. Up to now, the only considered epistemic variability of the source model is about the uncertainty of  $M_{MAX}$ , while neglecting any possible error on  $b$ -value and occurrence rate estimates. This was mostly done to reduce the complexity of the logic-tree structure - by limiting the total number of parameter permutations - but it might have the drawback to underestimate the true hazard in some regions. For future developments it is therefore advisable to perform a round of sensitivity tests to explore the impact of such epistemic variability on the results, as well as the integration of alternative source zonation models, to account for the subjective choice of regional discretization.

Finally, it is important to highlight that, although the presented model have been calibrated on the most recent information available for Sub-Saharan Africa and using state of the art tools for seismic hazard analysis, our interpretations should not be regarded as a final product, but should rather be regarded as a starting point for the development of continuously-updated and dynamically-improved snapshot of the current seismic hazard knowledge for the region. To make this process feasible, however, it is essential to ensure that all the model-related information (e.g. source models, SSA-catalogue, documentation) is open and publicly available to the community. GEM will support this policy by hosting model files into the GEM world database of open models.

## Acknowledgments



This study is made possible by the generous support of the American people through the United States Agency for International Development (USAID). The contents are the responsibility of GEM and do not necessarily reflect the views of USAID or the United States Government. *AfricaArray* projects that have provided seismicity information used for this study have been supported by the U.S. National Science Foundation.

We would like to thank Dr. Duncan Macgregor for having provided the African fault database. A special thanks goes also to Dr. Dario Slejko and the anonymous reviewer for their appreciation for our work and their insightful suggestions.

## References

- Adams, A., Nyblade, A. and Weeraratne, D., 2012. Upper mantle shear wave velocity structure beneath the East African Plateau: Evidence for a deep, plateau-wide low velocity anomaly, *Geophysical Journal International*, 189, 1, 1213-142.
- Akkar, S., Sandikkaya, M. A. and Bommer, J. J., 2014. Empirical ground-motion models for point- and extended-source crustal earthquake scenarios in Europe and the Middle East, *Bulletin of Earthquake Engineering*, 12, 359-387.
- Ambraseys, N. N., 1991a. The Rukwa earthquake of 13 Dec. 1910 in E. Africa. *Terra Nova*, 3, 203-208.
- Ambraseys, N. N., 1991b. Earthquake hazard in the Kenya Rift: the Subukia earthquake 1928. *Geophysical Journal International*. 105, 253-269.
- Ambraseys, N. N. and Adams, R. D., 1991. Reappraisal of major African earthquakes, south of 20°N, 1900-1930. *Natural Hazards*, 4, 389-419.
- Atkinson, G. and Boore, D., 2006. Earthquake ground-motion prediction equations for eastern North America, *Bull. Seismol. Soc. Am.* 96, 2181-2205.
- Barth, A., Wenzel, F. and Giardini, D., 2007. Frequency sensitive moment tensor inversion for light to moderate magnitude earthquakes in eastern Africa. *Geophys. Res. Lett.* 34, L15302.
- Ayele, A., Nyblade, A. A., Langston, C. A., Cara, M. and Leveque, J., 2006. New evidence for Afro-Arabian plate separation in southern Afar, in *The Structure and Evolution of the East African Rift System in the Afar Volcanic Province*, edited by G. Yirgu, C.J. Ebinger, and P.K.H. Maguire, Geological Society, London, Special Publication, 259, 254-263.
- Brazier, R., Miao, Q., Nyblade, A., Ayele, A. and Langston, C., 2008. Local magnitude scale for the Ethiopian Plateau, *Bulletin of the Seismological Society of America*, 98, 2341-2348, doi: 10.1785/0120070266.
- Brazier, R.A., Nyblade A. A. and Florentin, J., 2005. Focal mechanisms and the stress regime in NE and SW Tanzania, *Geophysical Research Letters*, 32, L14315, doi:10.1029/2005GL023156.
- Brzev S., Scawthorn, C., Charleson, A.W., Allen, L., Greene, M., Jaiswal, K. and Silva, V., 2013. GEM Building Taxonomy Version 2.0, GEM Technical Report 2013-02 V1.0.0, 188 pp., GEM Foundation, Pavia, Italy, doi:10.13117/GEM.EXP-MOD.TR2013.02.
- BSSC, Building Seismic Safety Council, 2003. The 2003 NEHRP Recommended provisions for new buildings and other structures, Part 1: Provisions (FEMA 450), [www.bssconline.org](http://www.bssconline.org).

- Casey, M., Ebinger, C., Keir, D., Gloagen, R. and Mohamed, R., 2006. Strain accommodation in transitional rifts: extension by magma intrusion and faulting in the Ethiopian rift magmatic segment. In: Yirgu, G., Ebinger, C.J., Maguire, P.K.H. (Eds.), *The Afar volcanic province within the East African Rift System*. Geol. Soc. Lond. Spec. Publ. 259, 143-163.
- CEN, European Committee for Standardization, 2004. Eurocode 8: Design of structures for earthquake resistance - Part 1: General rules, seismic actions and rules for buildings, British Standard BS EN 1998-1:2004: E, 219.
- Chesley, J. T., Rudnick, R. L. and Lee, C. T., 1999. Re-Ossystematics of mantle xenoliths from the East African Rift: Age, structure, and history of the Tanzanian craton. *Geochim. Cosmochim. Acta*, 63, 1203-1227.
- Chiou B. S.-J. and Youngs R. R., 2014. Update of the Chiou and Youngs NGA Model for the Average Horizontal Component of Peak Ground Motion and Response Spectra. *Earthquake Spectra*, 30, 3, 1117-1153.
- Chorowicz, J., 2005. The East African rift system. *Journal of African Earth Sciences*, 43, 379-410.
- Cotton, F., Scherbaum, F., Bommer, J. J. and Bungum, H., 2006. Criteria for selecting and adjusting ground motion models for specific target regions: Application to central Europe and rock sites. *Journal of Seismology*, 10, 2, 137-156.
- Craig, T. J., Jackson, J. A., Priestley, K., and McKenzie, D., 2011, Earthquake distribution patterns in Africa: their relationship to variations in lithospheric and geological structure, and their rheological implications. *Geophysical Journal International*, 185, 403-434.
- Dawson, J. B., 1992. Neogene tectonics and volcanicity in the North Tanzania sector of the Gregory Rift Valley: Contrasts with the Kenya sector. *Tectonophysics*, 204, 81-92.
- Delvaux, D. and Barth, A., 2010. African stress pattern from formal inversion of focal mechanism data. *Tectonophysics*, 482, 105-128.
- Delvaux, D., Mulumba, J. - L., Fiamma Bondo, S., Kervyn, F., and Havenith, H. - B. (2016). Seismic hazard assessment of the Kivu rift segment based on a new seismotectonic zonation model (Western Branch, East African Rift system), *J. African Earth Sci.*, AVCoR Special Issue, doi: 10.1016/j.jafrearsci.2016.10.004 (in press).
- Delvaux, D., Kervyn, F., Macheyeke, A. S. and Temu, E. B., 2012. Geodynamic significance of TRM segment in East African Rift (W-Tanzania): active tectonics and paleostress in the Ufipa plateau and Rukwa basin. *J. Struct. Geol.*, 37, 161-180.
- d'Oreye, N., Fernandez, J., Gonzalez, P., Kervyn, F., Wauthier, C., Frischknecht, C., Calais, E., Heleno, S., Cayol, V., Oyen, A. and Marinkovic, P., 2008. Systematic InSAR monitoring of African active volcanic zones: What we have learned in three years, or an harvest beyond our expectations. *Second Workshop on Use of Remote Sensing Techniques for Monitoring Volcanoes and Seismogenic Areas, USEReST 2008*, 57-62.
- Durrheim, R. J., 2016, African Earthquakes, In *Natural and Human-Induced Hazards and Disasters in Africa*, G. Mulugeta and T. Simelane (Eds.), Africa Institute of South Africa, Pretoria, 16-42.
- Edwards, B., Allmann, B., Fäh, D. and Clinton, J., 2010. Automatic computation of moment magnitudes for small earthquakes and the scaling of local to moment magnitude. *Geophysical Journal International*, 183, 1, 407-420.

- Engdahl, E. R., and Villaseñor, A., Global Seismicity: 1900-1999, 2002. in W.H.K. Lee, H. Kanamori, P.C. Jennings, and C. Kisslinger (editors), International Handbook of Earthquake and Engineering Seismology, Part A, Chapter 41, 665-690, Academic Press.
- Ekström, G., Nettles, M., and Dziewonski, A. M., 2012. The global CMT project 2004-2010: Centroid-moment tensors for 13,017 earthquakes, *Phys. Earth Planet. Inter.*, 200-201, 1-9.
- Fenton, C. H. and Bommer, J. J., 2006. The  $M_w$  7.0 Machaze Mozambique earthquake of 23 February 2006. *Seismol. Res. Lett.*, 77, 425-439.
- Field, E. H., Jordan, T. H. and Cornell, C. A., 2003. OpenSHA - A developing Community - Modeling Environment for Seismic Hazard Analysis. *Seism. Res. Lett.* 74, 406-419.
- Franke, D., Jokat, W., Ladage, S., Stollhofen, H., Klimke, J., Lutz, R., Mahanhane, E.S., Ehrhardt, A. and Schreckenberger, B., 2015. The offshore East African Rift System: Structural framework at the toe of a juvenile rift. *Tectonics*, 34, 10, 2086-2104.
- Furman, T. K., Kaleta, J., Bryce, J. and Hanan, B., 2006. Tertiary mafic lava of Turkana, Kenya: Constraints on EAST African plume structure and the occurrence of high  $\mu$  volcanism in Africa, *J. Petro.*, 47, 6, 1221-1244.
- Gardner, J. K. and Knopoff, L., 1974, Is the sequence of earthquakes in Southern California, with aftershocks removed, Poissonian? *Bulletin of the Seismological Society of America*, 64, 1363-1367.
- Grimison, N.L., Chen and W. P., 1988. Earthquakes in Davie Ridge-Madagascar region and the southern Nubian-Somalian plate boundary. *J. Geophys. Res.*, 93, 10439-10450.
- Gurnis, M., Mittovica, J., Ritsema, J. and Van Hest, H. J., 2000. Constraining mantle density structure using geological evidence of surface uplift rates: The case of African super-plume. *Geochem Geophys Geosyst*, 1, 10220.
- Hartnady, C. J. H., Ben-Avraham, H. Z. and Rogers, J., 1992. Deep-ocean basin basins and submarine rises of the continental margin of south-eastern Africa: New geological research. *S. Afr. J. Sci.*, 88, 534-539.
- Hartnady, C. J. H., 1990. Seismicity and plate boundary evolution in Southeastern Africa, *S. Afr. J. Sci.*, 93, 473-484.
- Hartnady, C. J. H., 2002. Earthquake hazard in Africa: perspectives on the Nubia-Somalia boundary. *S. Afr. J. Sci.*, 98, 425-428.
- Kebede, F. and Kulhanek, O., 1991. Recent seismicity of the East African rift system and its implications. *Phys. Earth. Planet. Inter.*, 68, 259-273.
- Keir, D., Hamling, J., Ayele, A., Calais, E. and Wright, T., 2009. Evidence for focused magmatic accretion at segment centers from lateral dike injection captured beneath the Red Sea Rift in Afar. *Geology*, 37, 59-62.
- ISC, 2013. International Seismological Centre, On-line Bulletin, <http://www.isc.ac.uk>, Internatl. Seismol. Cent., Thatcham, United Kingdom.
- Langston, C. A., Brazier, R. A., Nyblade, A. A. and Owens, T. J., 1998. Local magnitude scale and seismicity rate for Tanzania, East Africa. *Bulletin Seismological Society of America*, 88, 712-721.
- Lithgow-Berteloni, C. and Silver, P.G., 1998. Dynamic topography, plate driving forces and the African superswell. *Nature*, 395, 269-272.
- Lubkowsky, Z., Villani, M., Coates, K., Jirouskova, N. and Willis, M., 2014. Seismic design considerations for East Africa. Second European Conference on Earthquake Engineering and Seismology, 25-29 August 2014, 14 pages.

- McConnell, R. B., 1980. A resurgent taphrogenic lineament of Precambrian origin in eastern Africa. *J. Geol. Soc. London*, 137, 483-489.
- Macgregor, D., 2015, History of the development of the East African Rift System: A series of interpreted maps through time. *Journal of African Earth Sciences*, 101, 232-252.
- Mavonga, T., 2007. Some characteristics of aftershock sequences of major earthquakes from 1994 to 2002 in the Kivu Province, Western Rift Valley of Africa. *Tectonophysics*, 439, 1-12.
- Mavonga T., Durrheim R.J., 2009. Probabilistic seismic hazard assessment for the Democratic Republic of Congo and surrounding areas, *South African J. Geol.*, 112, 329-342.
- McDougall, I. and Brown, F.H., 2009. Timing of volcanism and evolution of northern Kenya Rift. *Geol. Mag.* 146, 1, 34-47.
- McGuire, R. K. 2004. *Seismic hazard and risk analysis*, Earthquake Engineering Research Institute, Oakland, CA.
- Midzi, V., and Manzunzu, B., 2014, Large recorded earthquakes in sub-Saharan Africa. In *Extreme Natural Hazards, Disaster Risks and Societal Implications*, ed. A. Ismail-Zadeh, J. Urrutia-Fucagauchi, A. Kijko and I Zaliapin. Cambridge: Cambridge University Press.
- Midzi, V., Hlatywayo, D. J., Chapola, L. S., Kebede, F., Atakan, K., Lombe, D. K., Turyomurugendo G. and Tugume, F. A., 1999). Seismic hazard assessment in eastern and Southern Africa. *Annali di Geofisica*, 42, 1067-1083.
- Mulibo, G.D. and Nyblade, A.A., 2013. Mantle transition zone thinning beneath eastern Africa: Evidence for a whole - mantle superplume structure. *Geophysical Research Letters*, 40, 3562-3566.
- Mulibo, G. and A. Nyblade, 2016, The seismotectonics of southeastern Tanzania: Implications for the propagation of the Eastern Branch of the East African Rift, *Tectonophysics*, 974, 2, 20-30.
- Mulwa, J.,K., Kimata, F., Suzuki, S. and Kuria, Z.N., 2014. The seismicity in Kenya (East Africa) for the period 1906–2010: A review. *Journal of African Earth Sciences*. 89, 72–78.
- Nyblade, A. A., and Langston, C. A., 1995. East African earthquakes below 20 km depth and their implications for crustal structure. *Geophysical Journal International*, 121, 49-62.
- Nyblade, A. A. and Robinson, S. W., 1994. The African superswell. *Geophys. Res. Lett.* 21, 9, 765-768.
- Pagani, M., Monelli, D., Weatherill, G., Danciu, L., Crowley, H., Silva, V., Henshaw, P., Butler, L., Nastasi, M., Panzeri, L., Simionato, M. and Viganò, D., 2014. OpenQuake-engine: An open hazard (and risk) software for the Global Earthquake Model. *Seismological Research Letters*, 85, 3, 692-702.
- Petit, C., and C. Ebinger, 2000. Flexure and mechanical behaviour of cratonic lithosphere: Gravity models of the East African and Baikal rifts. *J. Geophys. Res.*, 105, 19151-19162.
- Pezeshk, S., Zandieh, A. and Tavakoli, B., 2011. Hybrid Empirical Ground-Motion Prediction Equations for Eastern North America Using NGA Models and Updated Seismological Parameters. *Bull Seism. Soc. Am.*, 101, 4, 1859-1870.
- Pik, R., Marty, B., Carignan, J., Lave, J., 2003. Stability of the upper Nile drainage network (Ethiopia) deduced from (U-Th)/He thermochronometry: implication for uplift and erosion of the Afar plume dome. *Earth. Planet. Sci. Lett.* 215. 73-88.

- Poggi, V., Edwards, B. and Fäh, D., 2016. A comparative analysis of site-specific response spectral amplification models. *Physics and Chemistry of the Earth, Special Issue*, In press.
- Reiter, L., 1990. *Earthquake Hazard Analysis*. Columbia University Press, New York, 254 pp.
- Ritsema, J. H., Van Hest, H. J. and Woodhouse, J. H., 1998. Complex shear wave velocity structure imaged beneath Africa and Iceland. *Science*, 286, 1925-1928.
- Roberts, E. M., Stevens, N.J., O'Connor, P. M., Dirks, P. H. G. M., Gottfried, M. D., Clyde, W. C., Armstrong, R. A., Kemp, A. I. S. and Hemming, S., 2012. Initiation of the Western Branch of the East African Rift, coeval with the eastern Branch. *Nat. Geosc.*, 5, 4, 289-294.
- Rydelek, P.A., and Sacks, J.S., 1989. Testing the completeness of Earthquake Catalogues and the Hypothesis of Self-Similarity. *Nature*, 337, 249-251.
- Saria, E., Calais, E., Stamps, D.S., Delvaux, D. and Hartnady, C. J. H., 2014. Present-day kinematics of the East African Rift, *Journal of Geophysical Research Solid Earth*, 119(4), 3584-3600, doi:10.1002/2013JB010901.
- Shudofsky, G.N., 1985. Source mechanisms and focal depths of East African earthquakes using the Rayleigh-wave inversion and body-wave modelling. *Geophys. J. R., Astr.Soc.*, 83, 563-634.
- Stamps, D.S., Saria, E. and Kreemer, C., 2015. Sub-Saharan Africa Geodetic Strain Rate Model 1.0. GEM Technical report.
- Stepp, J. C., 1971. An investigation of earthquake risk in the Puget Sound area by use of the type I distribution of largest extremes. PhD thesis, Pennsylvania State University.
- Stiphout, T. van, Zhuang, J. and Marsan, D., 2012. Theme V - Models and Techniques for Analysing Seismicity. Technical report. Community Online Resource for Statistical Seismicity Analysis. doi:10.5078/corssa-52382934.
- Storchak, D.A., Di Giacomo, D., Engdahl, E. R., Harris, J., Bondár, I., Lee, W. H. K., Bormann P. and Villaseñor, A., 2015. The ISC-GEM Global Instrumental Earthquake Catalogue (1900-2009). Introduction, *Phys. Earth Planet. Int.*, 239, 48-63.
- Storchak, D. A., Di Giacomo, D., Bondár, I., Engdahl, E. R., Harris, J., Lee, W.H.K., Villaseñor A. and Bormann, P., 2013. Public Release of the ISC-GEM Global Instrumental Earthquake Catalogue (1900-2009). *Seism. Res. Lett.*, 84, 5, 810-815.
- Studt, F. E., Cornet, J. and Buttgenbach, H., 1908. Carte géologique du Katanga et notes descriptive. *Am. Musée Congo*, Ser. 2, 1.
- Tanaka, K., S. Horiuchi, T. Sato and N. Zana, 1980. The earthquake generating stresses in the Western Rift Valley of Africa, *J. Phys. Earth*, 28, 45-57.
- Uhrhammer, R., 1986, Characteristics of Northern and Central California seismicity. *Earthquake Notes*, 57, 1, 21.
- USGS 2016, M5.9 - 22km NE of Nsungu, Tanzania. U.S. Geological Survey - Earthquake Hazards Program. <http://earthquake.usgs.gov/earthquakes/eventpage/us10006nknx#executive>. Accessed 12 September 2016.
- USNRC 2012. Practical implementation guidelines for SSHAC Level 3 and 4 hazard studies. Technical report. 235 pages. US Nuclear Regulatory Commission.
- Vilanova, S. P., Nemser, E. S., Besana-Ostman, G. M., Bezzeghoud, M., Borges, J. F., da Silveira, A. B., Cabral, J., Carvalho, J., Cunha, P. P., Dias, R. P., Madeira, J., Lopes, F. C., Oliveira, C. S., Perea, H., García-Mayordomo, J., Wong, I., Arvidsson, R., and Fonseca, J. F. B. D., 2014. Incorporating descriptive metadata into seismic source zone models for Seismic - Hazard Assessment: a case study of



- the Azores-West Iberian region. *Bulletin of the Seismological Society of America*, 104, 1212-1229.
- Vittori, E., Delvaux, D. and Kervyn, F., 1997. Kanda fault: a major seismogenic element west of the Rukwa Rift (East Africa: Tanzania). *J. Geophys.*, 24, 1-4, 139-153.
- Weatherill, G. A., Pagani, M. and Garcia, J., 2016, Exploring earthquake databases for the creation of magnitude-homogeneous catalogues: tools for application on a regional and global scale. *Geophys. J. Int.*, 206, 3, 1652-1676.
- Weatherill, G. A. 2014b. OpenQuake Ground Motion Toolkit - User Guide. Global Earthquake Model (GEM). Technical Report. DOI:10.13117/GEM.OPENQUAKE.MAN.GMTK.01
- Weatherill, G. A., 2014a. OpenQuake Hazard Modeller's Toolkit - User Guide. Global Earthquake Model (GEM). Technical Report. DOI:10.13117/GEM.OPENQUAKE.MAN.HMTK.01
- Weichert, D. H., 1980. Estimation of the earthquake recurrence parameters for unequal observation periods for different magnitudes. *Bulletin of the Seismological Society of America*, 70, 4, 1337-1346.
- Woessner, J. and Wiemer, S., 2005. Assessing the quality of earthquake catalogues: estimating the magnitude of completeness and its uncertainty. *Bulletin of the Seismological Society of America*, 95, 684-698.
- Wolfenden, E., Ebinger, C., Yiirgu, G., Deino and A., Ayalew, D., 2004. Evolution of the northern Main Ethiopian Rift: Birth of a triple junction. *Earth Planet. Sci.*, 224, 2123-228.
- Worku, A., 2014. The status of basic design ground motion provisions in seismic design codes of Sub-Saharan African countries. *Journal of the South African Institution of Civil Engineering*, 56, 40-53.
- Yang, Z., and Chen, W. P., 2010, Earthquakes along the East African Rift System: a multiscale, system-wide perspective. *Journal of Geophysical Research*, 115, B12309.
- Zana, N., Wafula, M., Lukaya, N. and Batabolo, M., 2004. The Kabalo earthquake in D. R. Congo on September 11, 1992: Field observations and damages. *Quelques résultats de Recherches en Géophysique. Centre de Recherches et Pédagogie appliqués (C. R. P. A), I.P.N, Kinshasa, 77-89.*